



**赫兹电力**  
HERTZ POWER

产品宗旨：技术领先，质量可靠，轻便易用  
服务宗旨：快速响应，达到满意，超过期望



**赫兹电力**  
HERTZ POWER

# WILLBROS

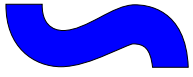

赫兹电力  
HERTZ POWER

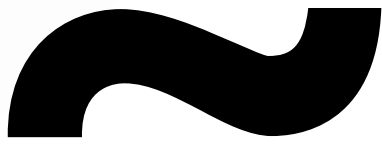

# WILLBROS



**赫兹电力**  
HERTZ POWER

产品宗旨：技术领先，质量可靠，轻便易用  
服务宗旨：快速响应，达到满意，超过期望



**赫兹电力**  
HERTZ POWER





**赫兹电力**  
HERTZ POWER

产品宗旨：技术领先，质量可靠，轻便易用  
服务宗旨：快速响应，达到满意，超过期望



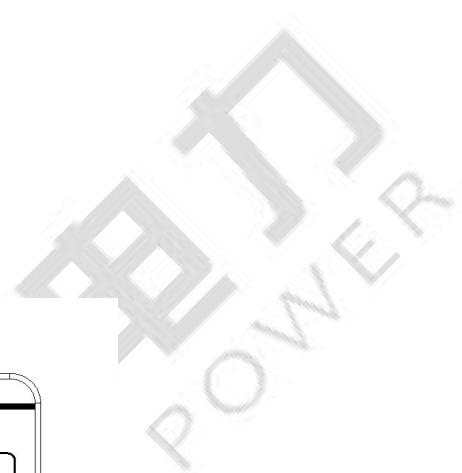
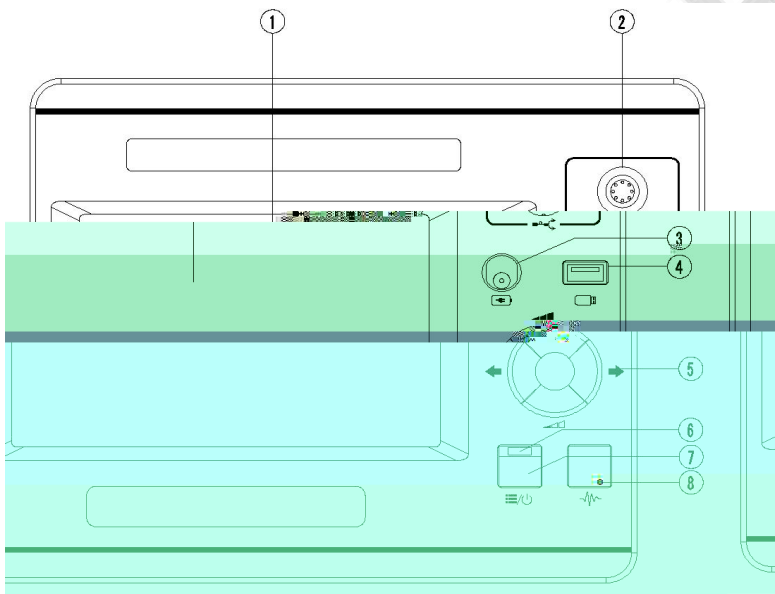

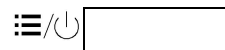
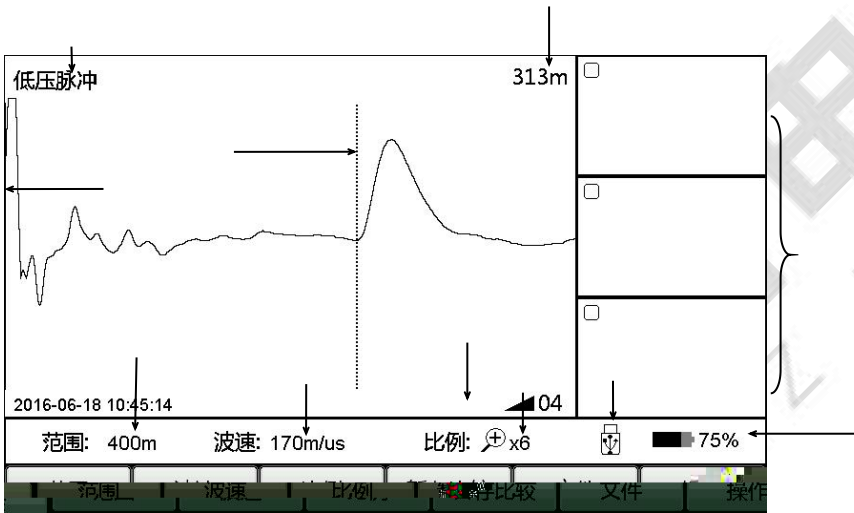
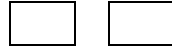
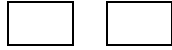



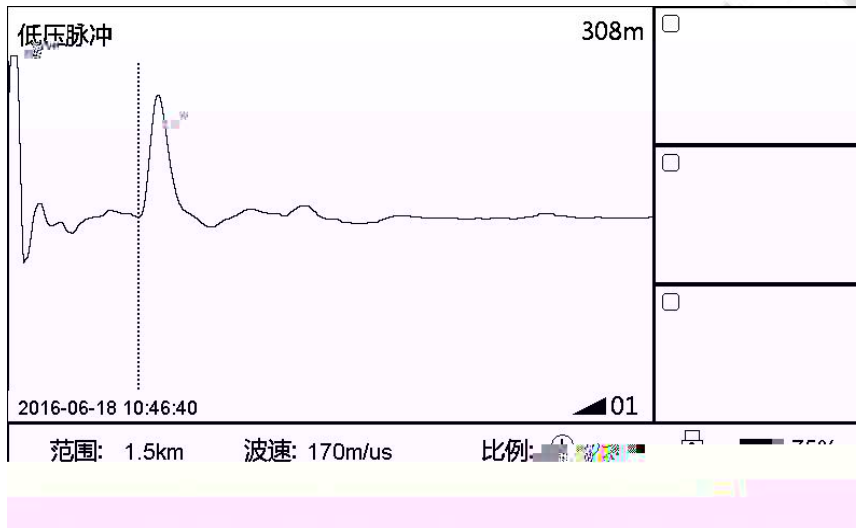

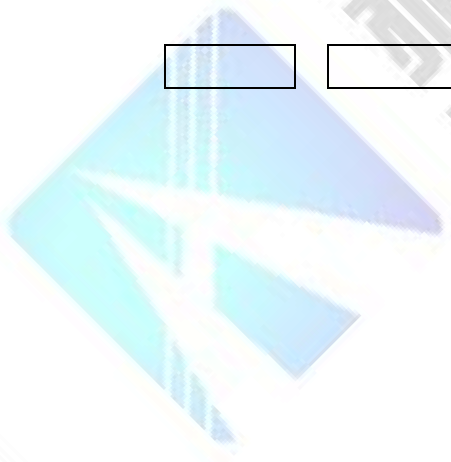
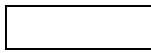
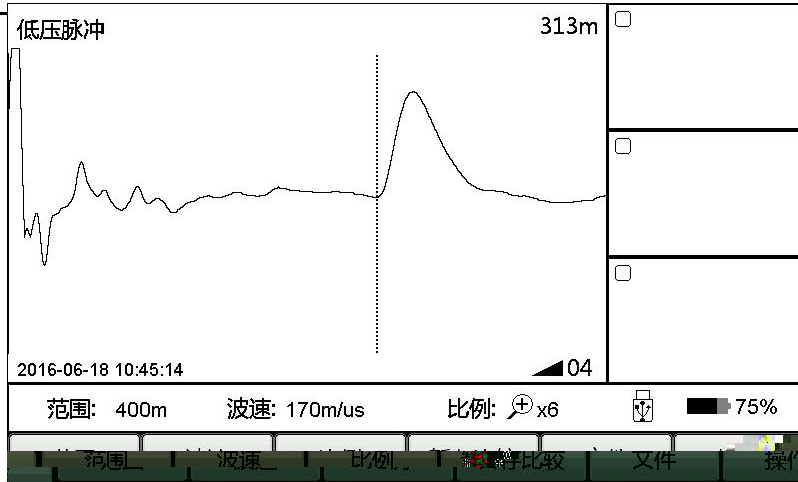

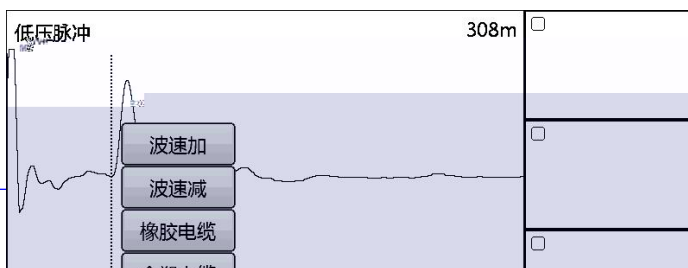
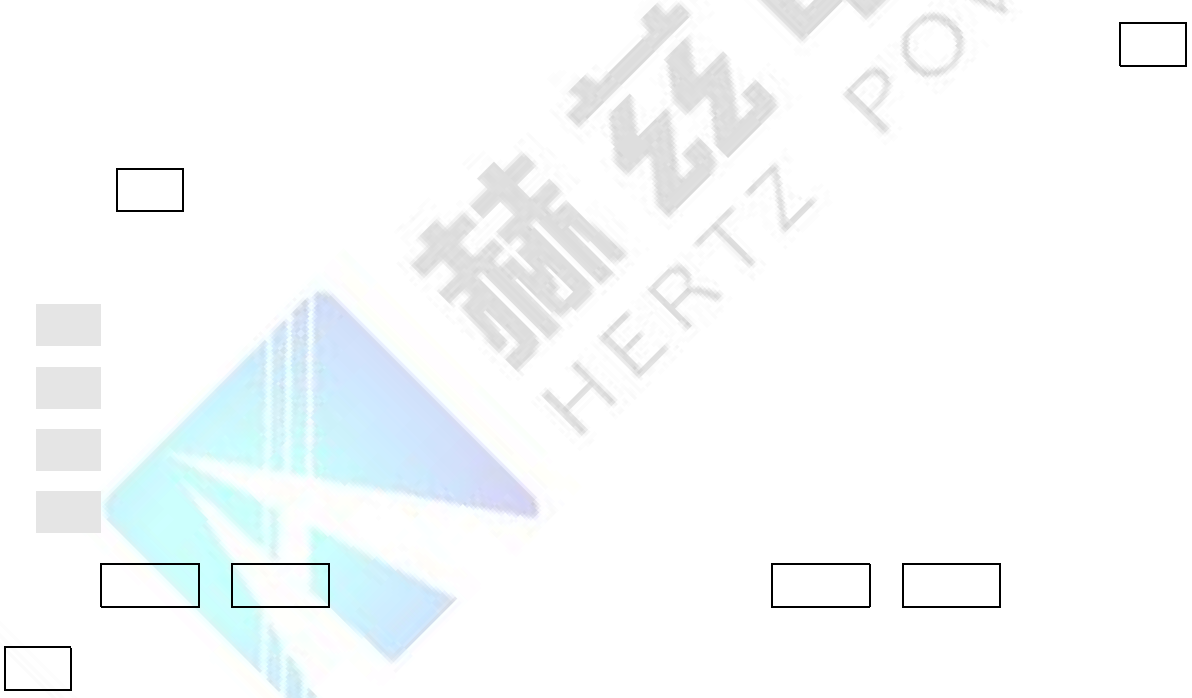
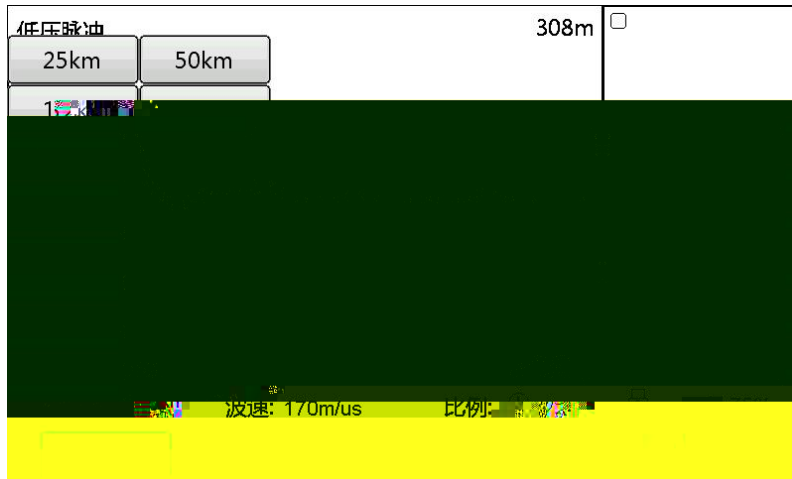

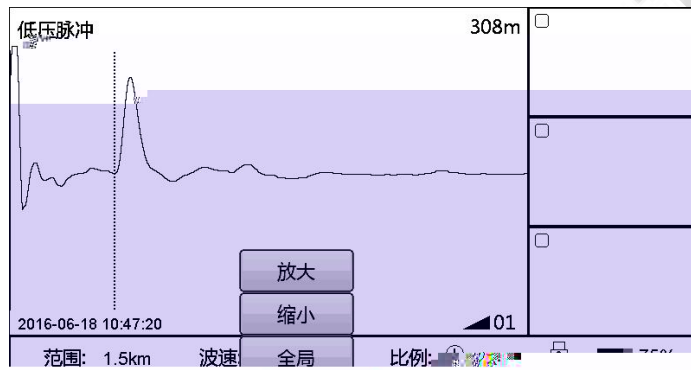

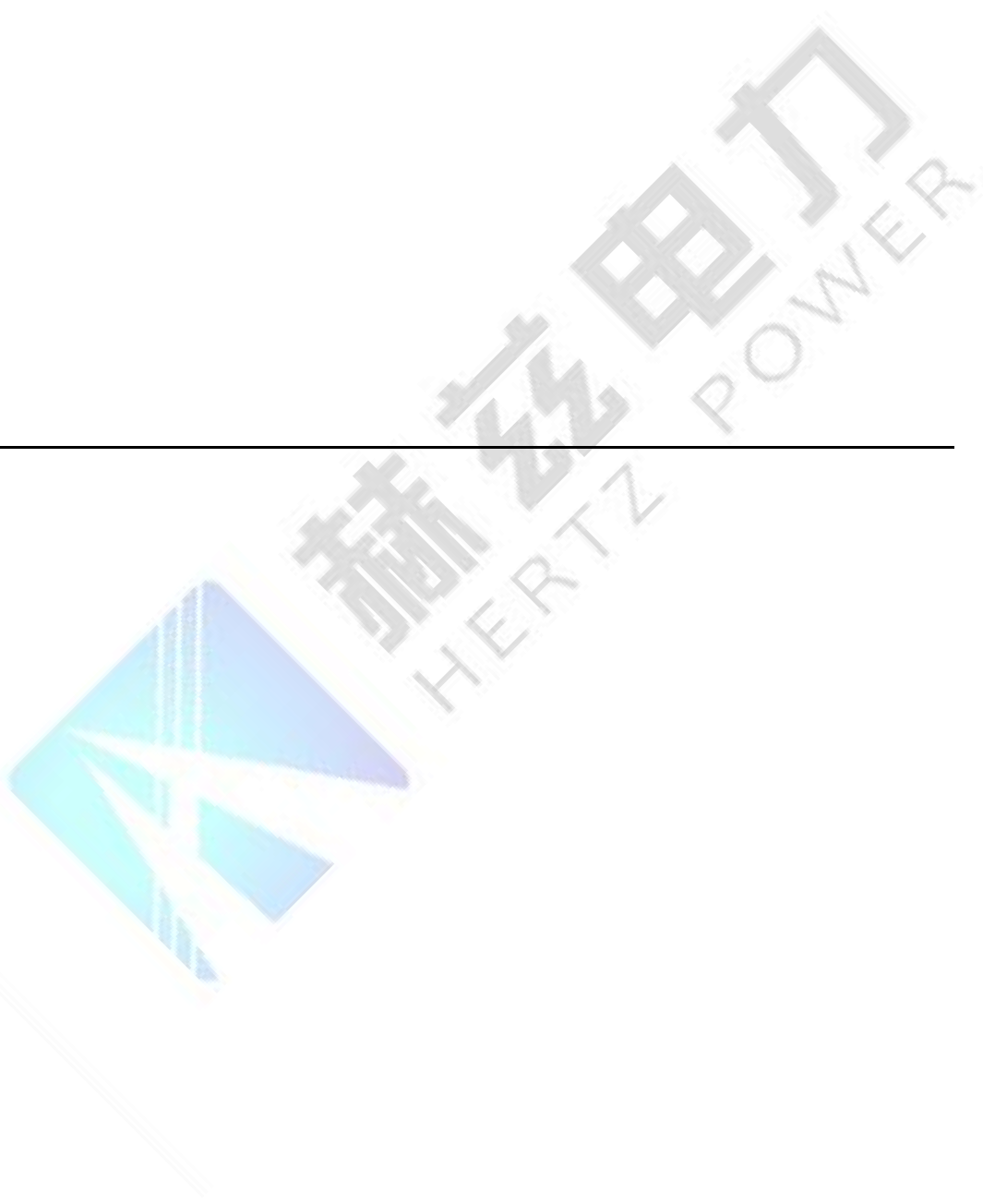

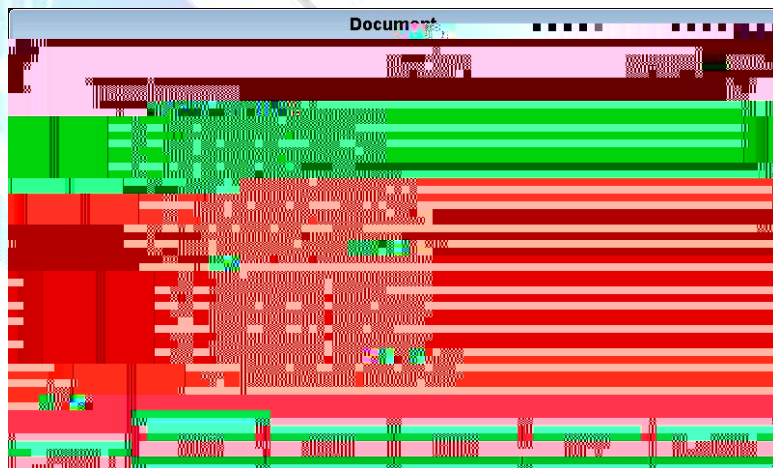
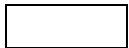
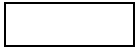
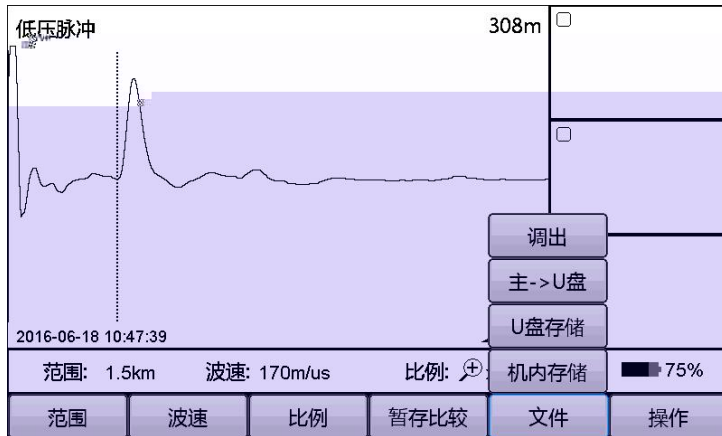





赫兹电力  
HERTZ POWER

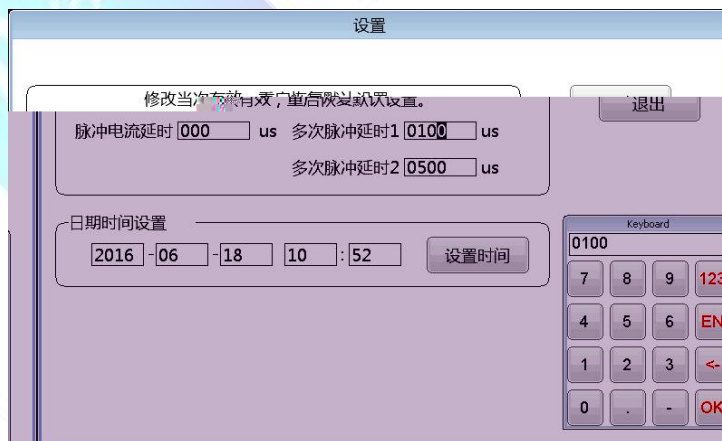

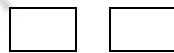
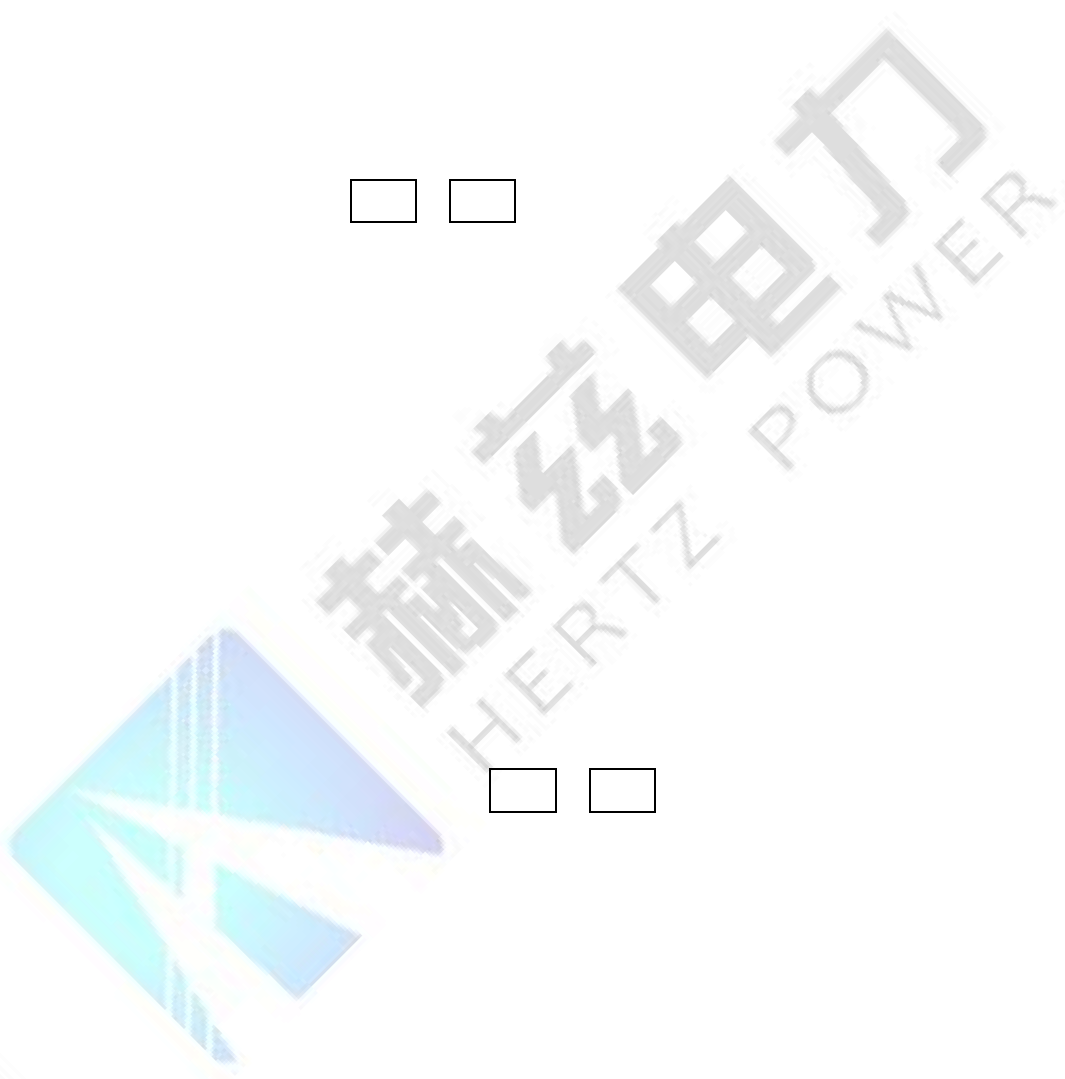
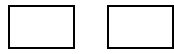





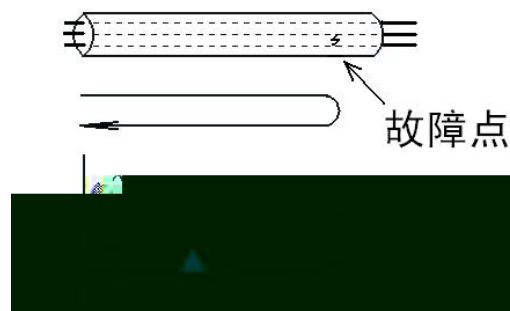

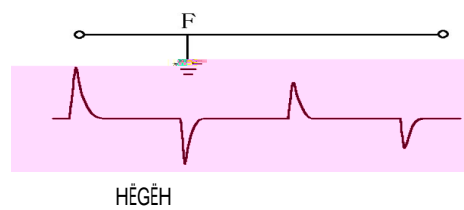
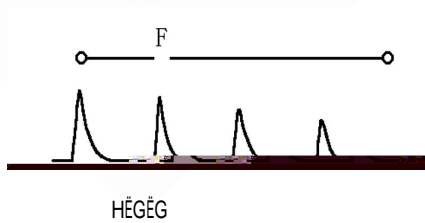
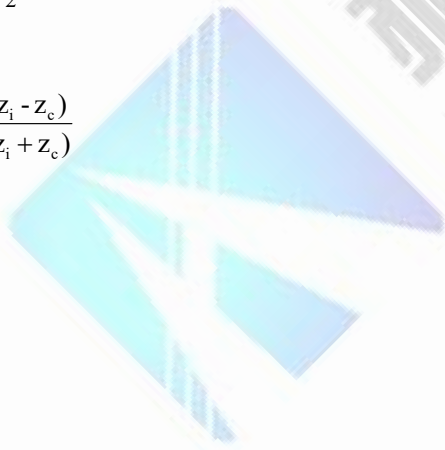

$$= \frac{1}{2}$$

$$= \frac{(z_i - z_c)}{(z_i + z_c)}$$

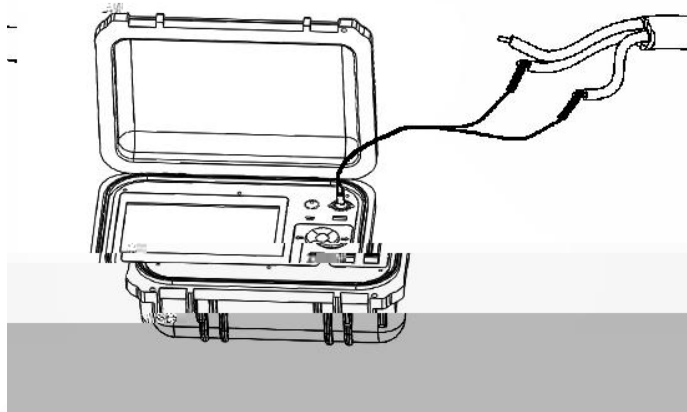



3-3-1





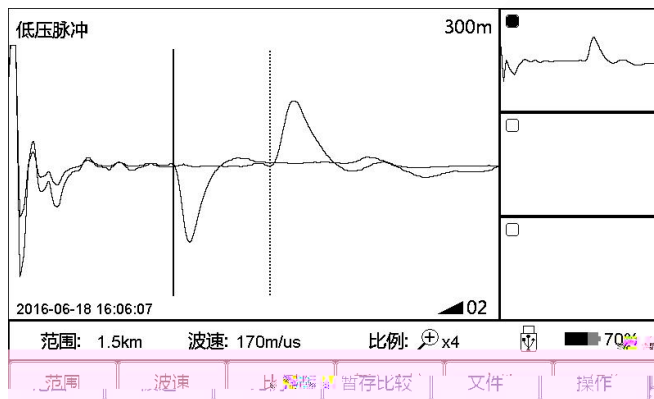



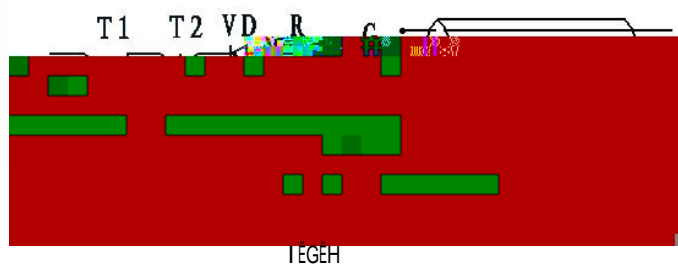
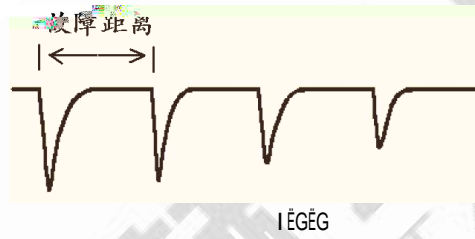
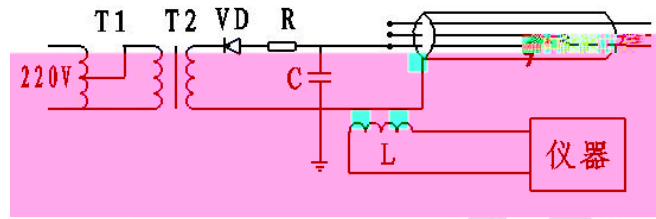



击穿延时 故障距离  
|←→|←→|



IÈÈI

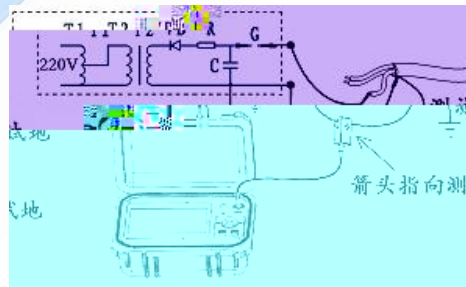
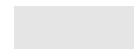
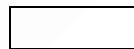
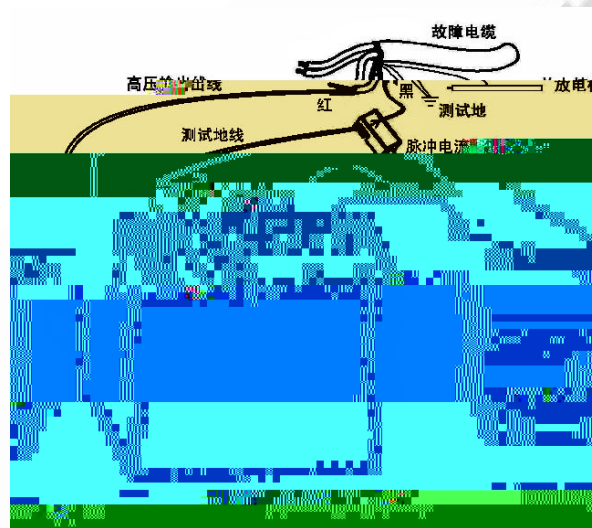

IÈÈG



- 
- 
- 
- 
- 



赫兹电力  
HERTZ POWER

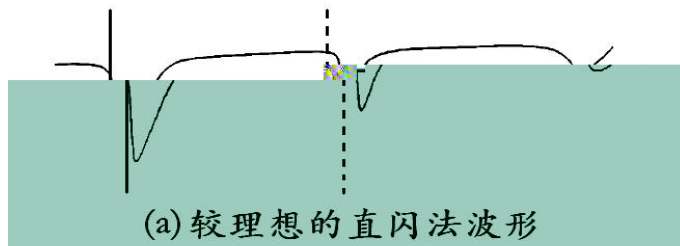

电感影响，造成波形畸变

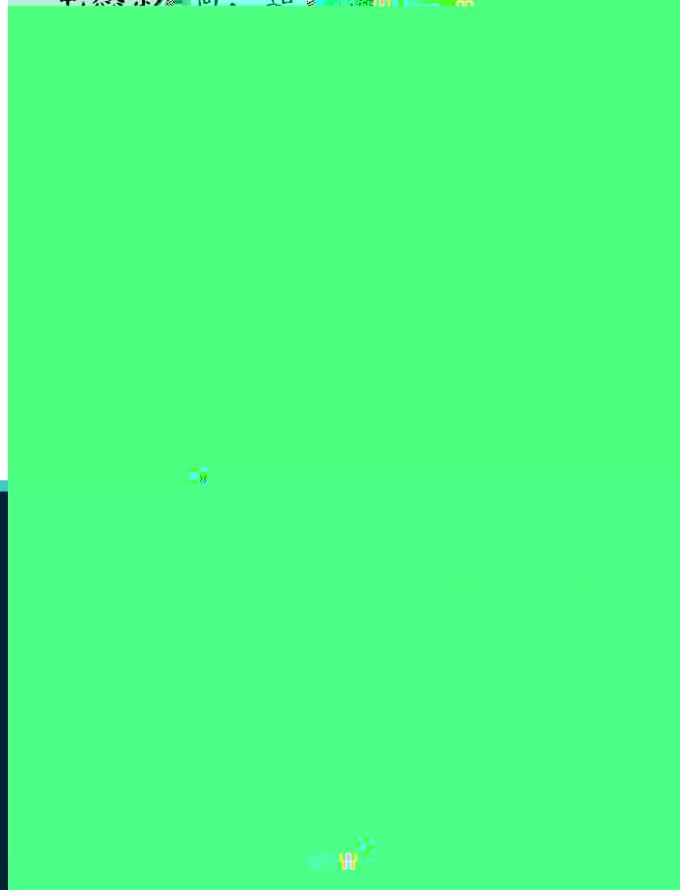

4-3-3

图 4-3-3 雷电冲击电压波形

图 4-3-3 雷电冲击电压波形



图 4-3-3 雷电冲击电压波形



图 4-3-3 雷电冲击电压波形

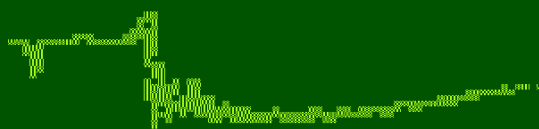

赫兹电力  
HERTZ POWER

- 
- 
- 
- 
- 



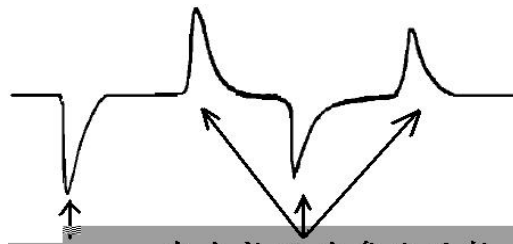

在全长两端多次反射  
球间隙放电脉冲



赫兹电力  
HERTZ POWER

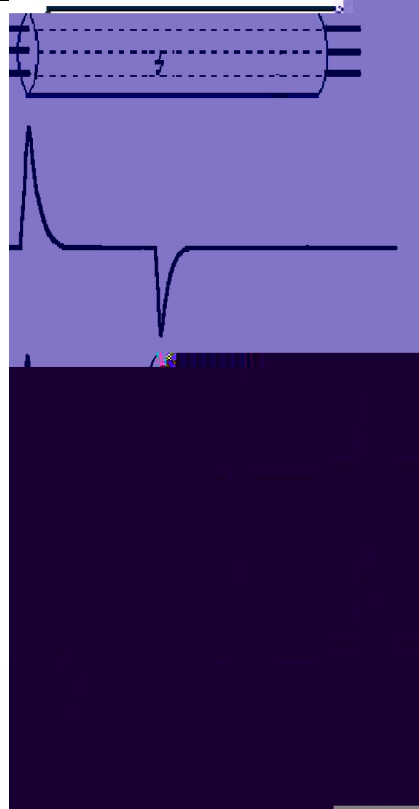

IEGÉF





- 
- 
- 
- 
- 



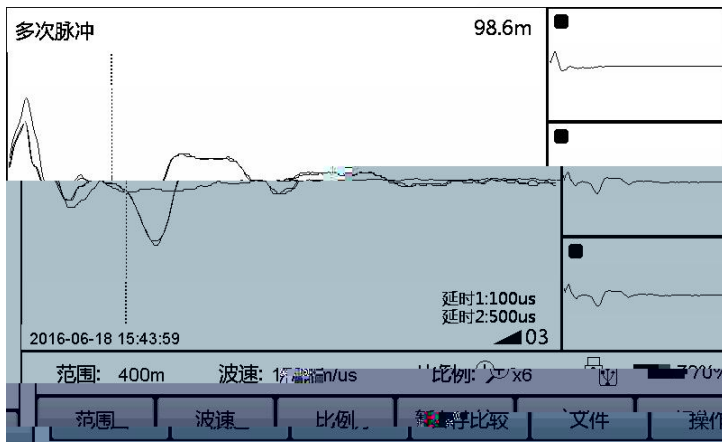





**赫兹电力**  
HERTZ POWER

产品宗旨：技术领先，质量可靠，轻便易用  
服务宗旨：快速响应，达到满意，超过期望



**赫兹电力**  
HERTZ POWER