



赫兹电力

产品宗旨：技术领先，质量可靠，轻便易用

服务宗旨：快速响应，达到满意，超过期望





赫兹电力

产品宗旨：技术领先，质量可靠，轻便易用

服务宗旨：快速响应，达到满意，超过期望





赫兹电力

产品宗旨：技术领先，质量可靠，轻便易用

服务宗旨：快速响应，达到满意，超过期望





赫兹电力

产品宗旨：技术领先，质量可靠，轻便易用

服务宗旨：快速响应，达到满意，超过期望

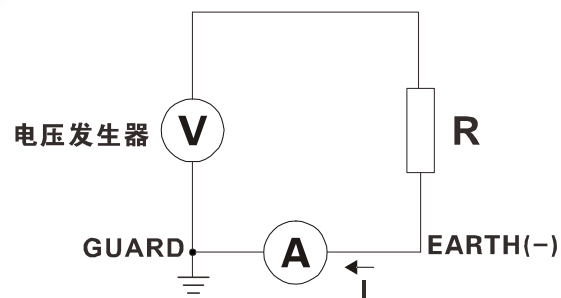

$$R = V / I$$



V \equiv

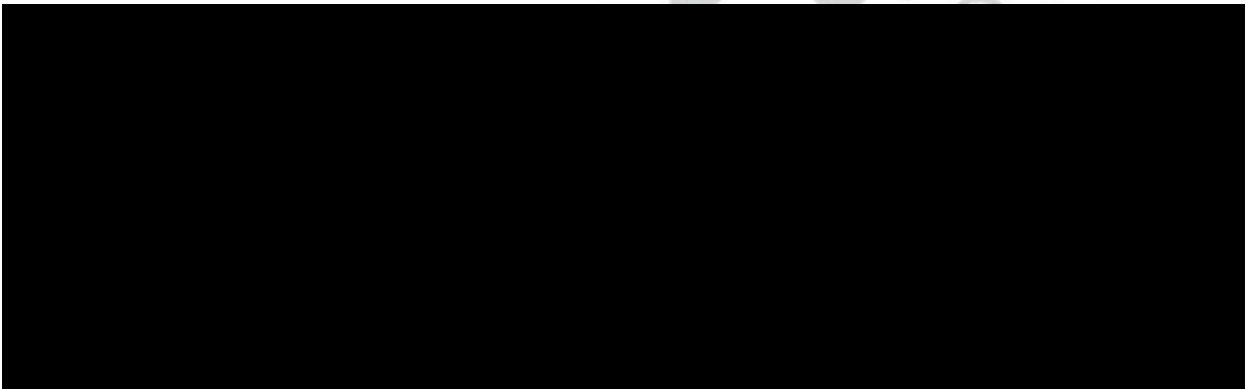

V ~



Ω

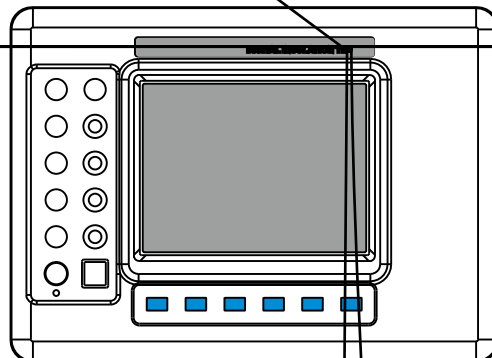

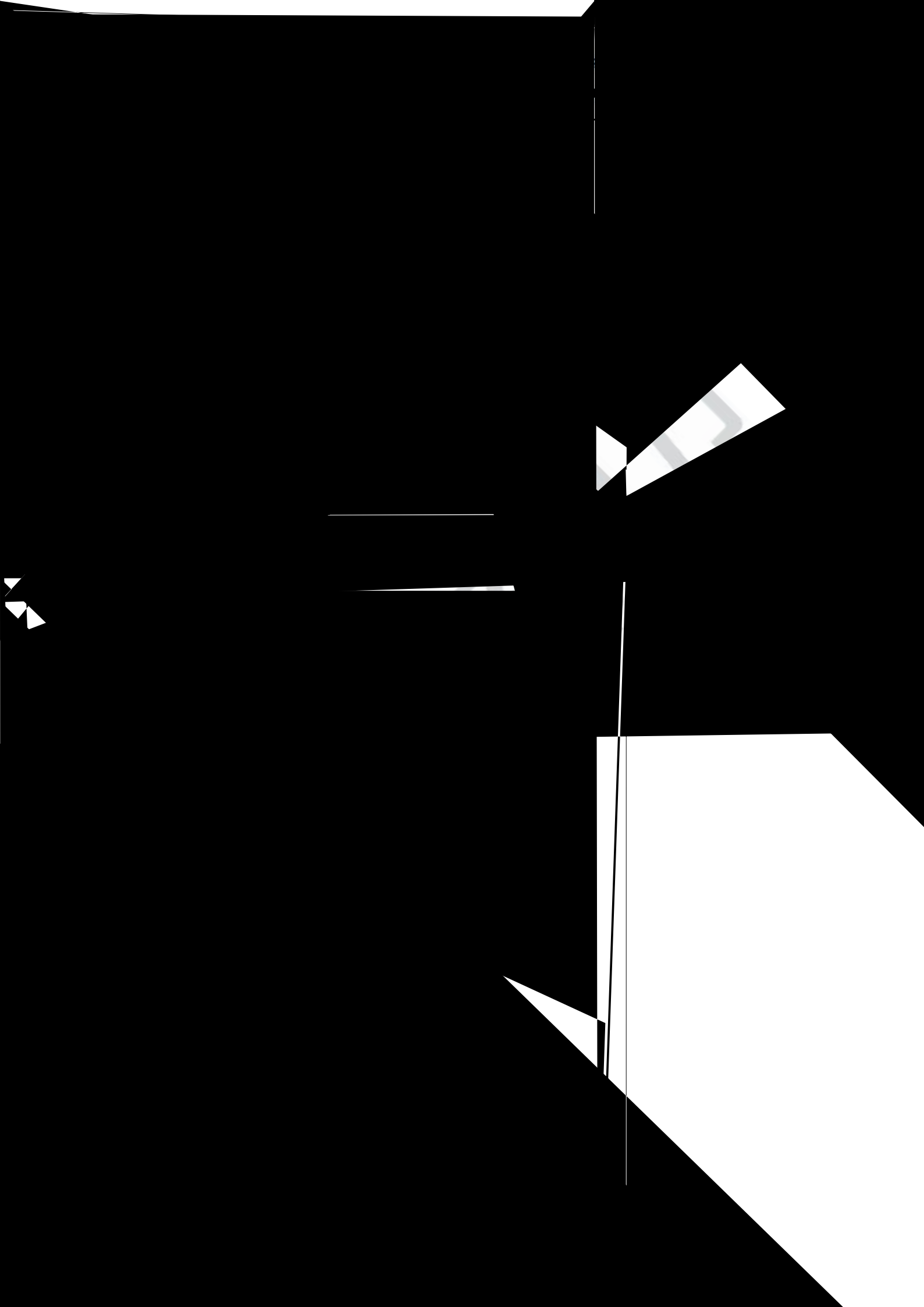



$$\frac{R \quad Min}{R \quad Min}$$

$$\frac{R \quad Sec}{R \quad Sec}$$

$$\frac{R \quad Sec}{R \quad Sec}$$

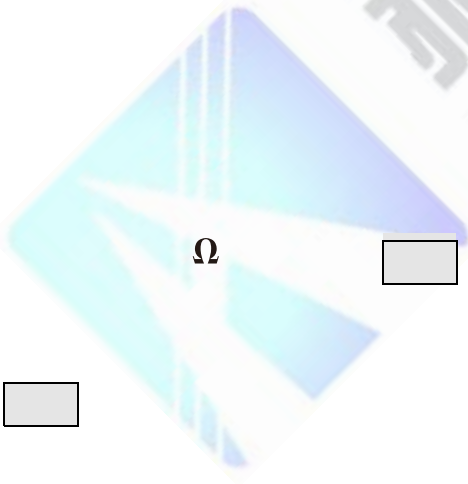

Ω



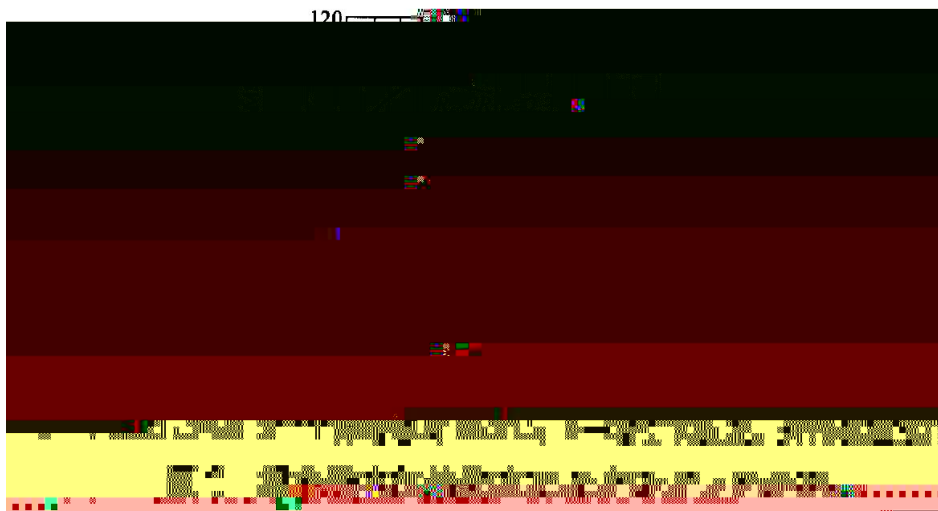



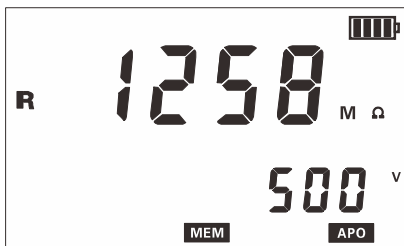
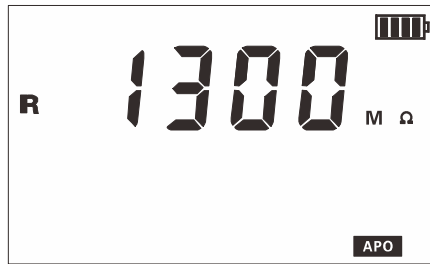



赫兹电力

产品宗旨：技术领先，质量可靠，轻便易用

服务宗旨：快速响应，达到满意，超过期望





赫兹电力
HERTZ POWER



赫兹电力

产品宗旨：技术领先，质量可靠，轻便易用

服务宗旨：快速响应，达到满意，超过期望

