



**赫兹电力**  
HERTZ POWER

产品宗旨：技术领先，质量可靠，轻便易用

服务宗旨：快速响应，达到满意，超过期望



# 安全策略



赫兹电力  
HERTZ POWER

# 应急响应

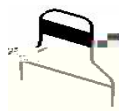
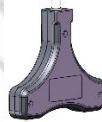



赫兹电

HERTZ POWER

宗旨：技术

靠，轻便易用

意，超过期租



Wí Jǎ+e56Wé 8 ŌAö[ Ö é ĩ

4

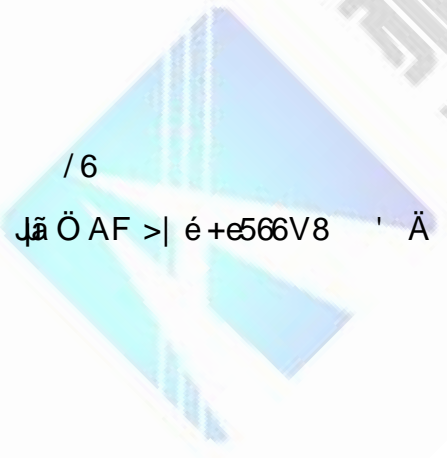

/6

j ǔä Ö AF >| é+e566V8 ' Ä



赫兹电力  
HERTZ POWER

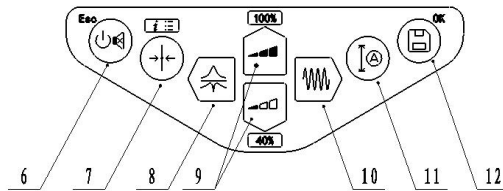
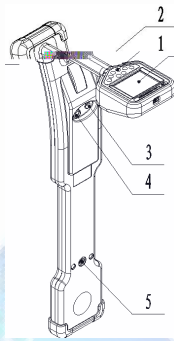
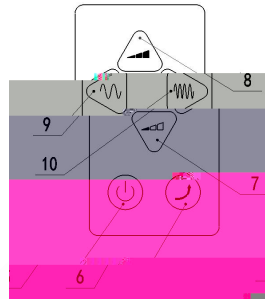
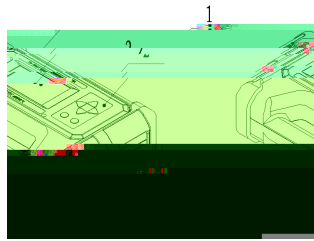

赫兹电力  
HERTZ POWER



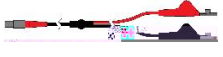





系统	存储	工频	单位	频率

发送全部

系统	存储	工频	单位	频率
			* 50Hz	
			60Hz	

系统	存储	工频	单位	频率
			* m	
			ft	



赫兹电力  
HERTZ POWER

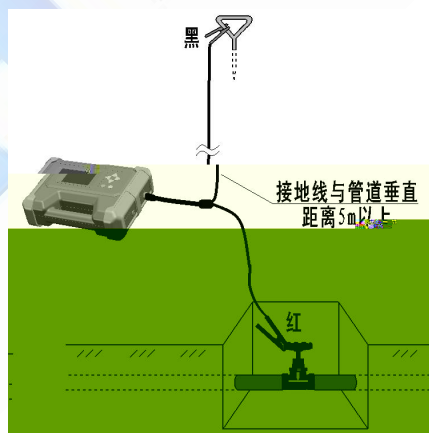
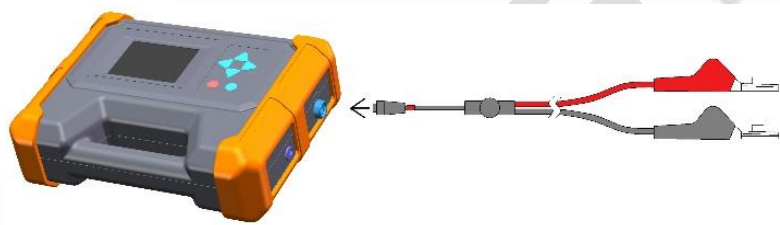

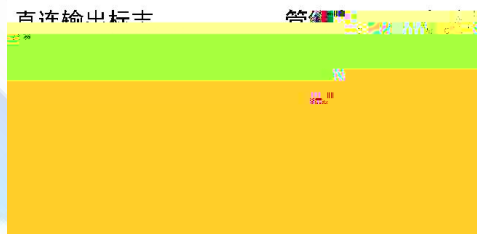

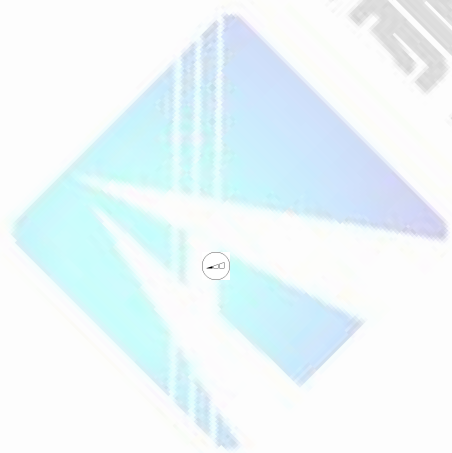
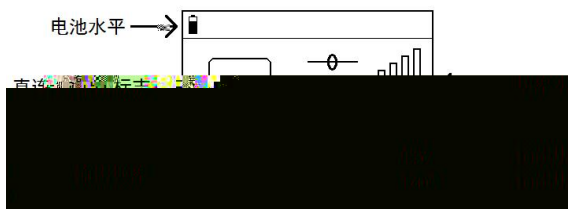

**赫兹电力**  
HERTZ POWER



赫兹电力  
HERTZ POWER

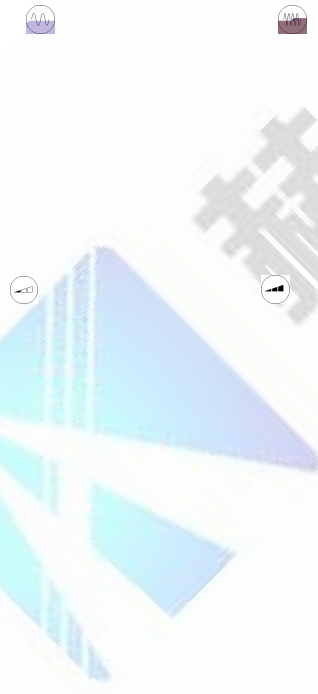
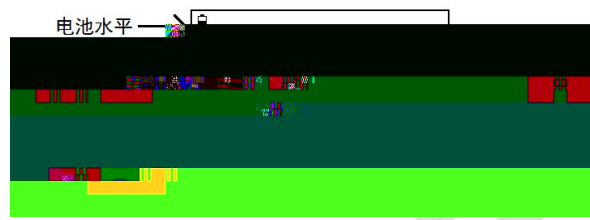

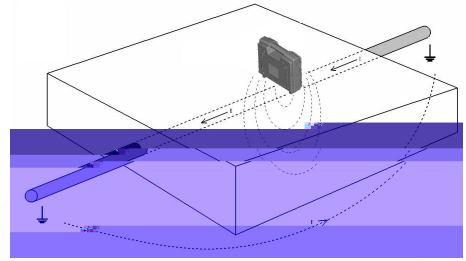

赫兹电力  
HERTZ POWER

电池水平



赫兹电力  
HERTZ POWER

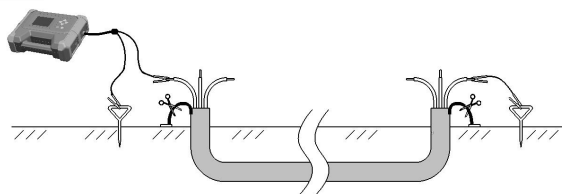

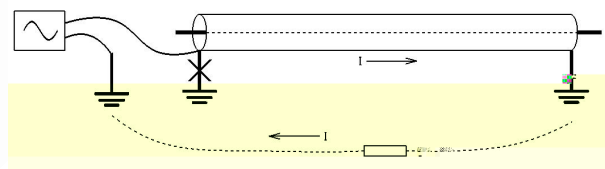
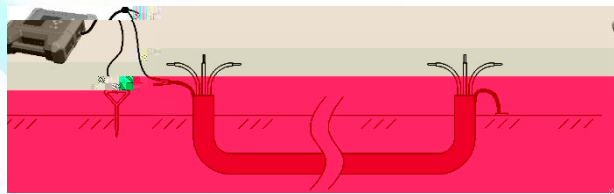
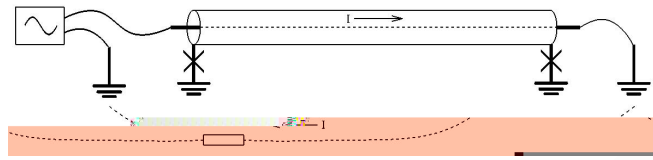

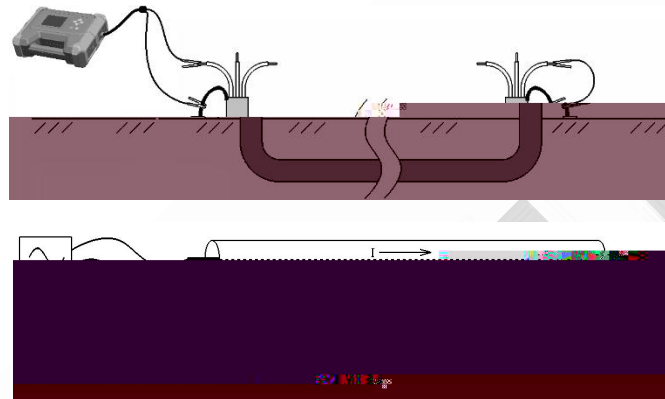

赫兹  
HERTZ POWER

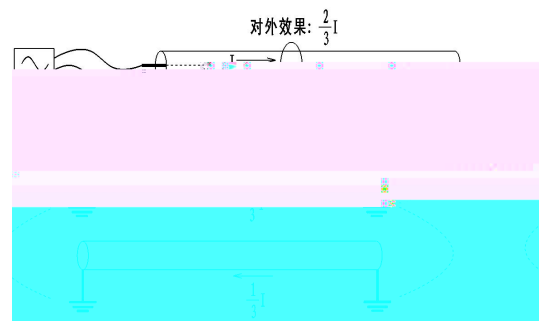



赫兹电力  
HERTZ POWER

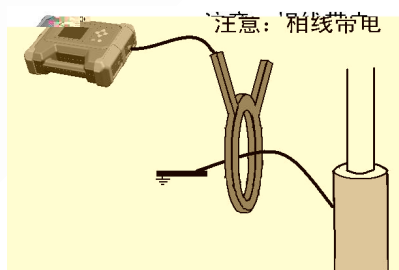
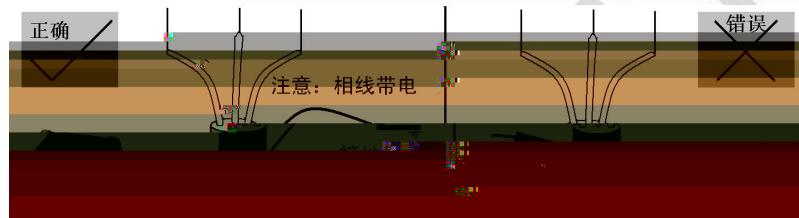

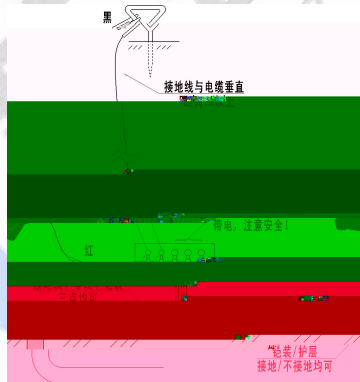

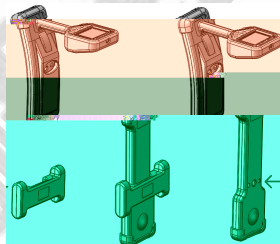

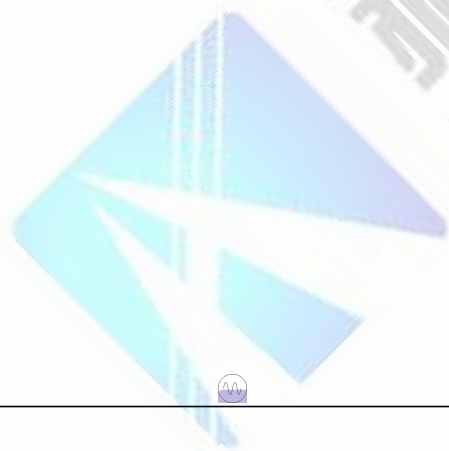
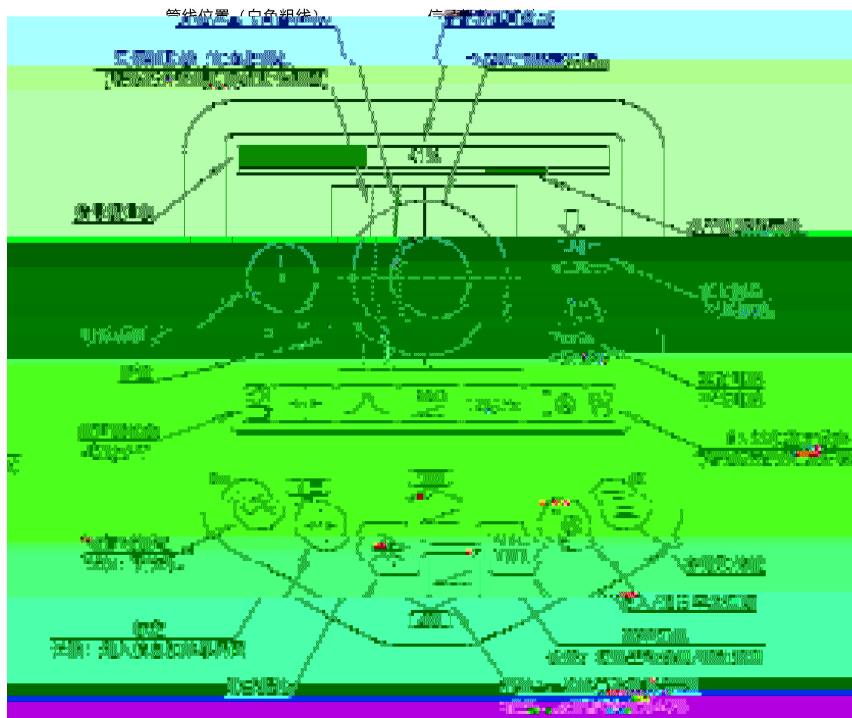

# 赫兹电力

HERTZ POWER







**赫兹电力**  
HERTZ POWER

产品宗旨：技术领先，质量可靠，轻便易用

服务宗旨：快速响应，达到满意，超过期望



赫兹电力  
HERTZ POWER

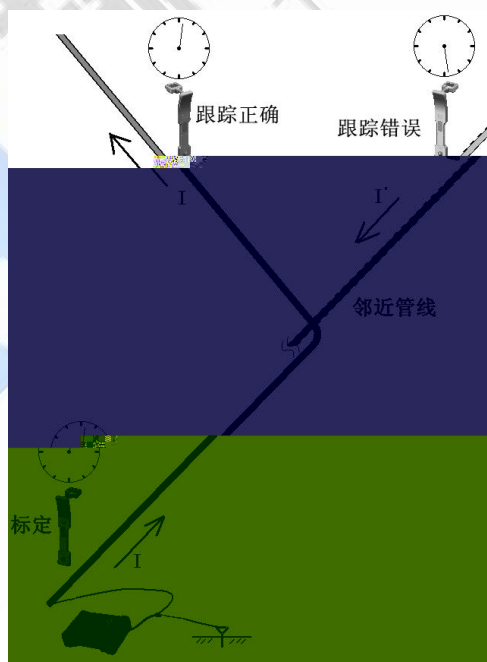
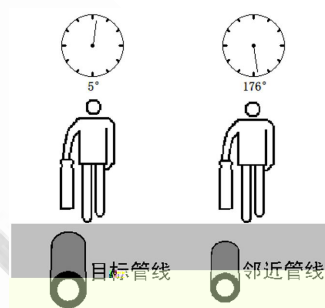

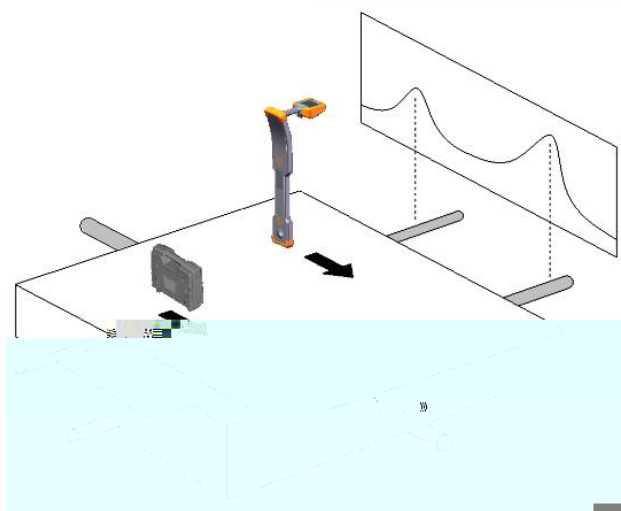

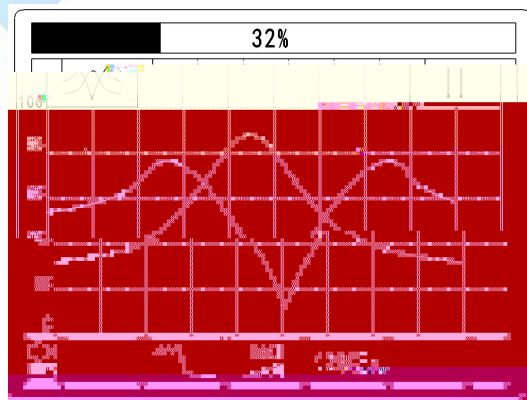
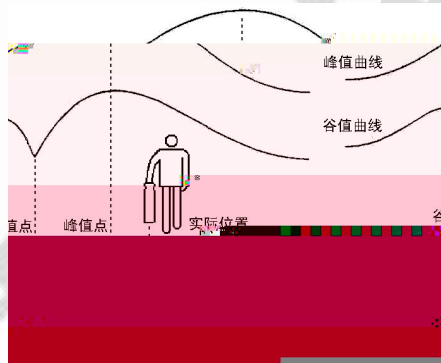
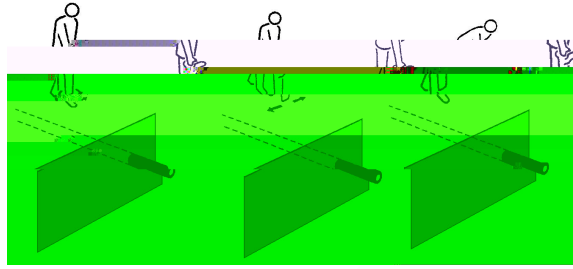



赫兹电力  
HERTZ POWER



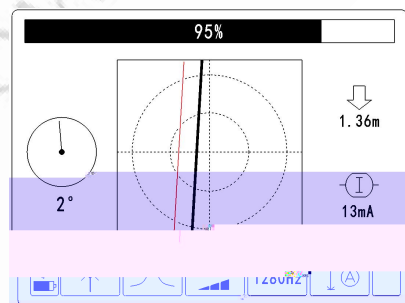
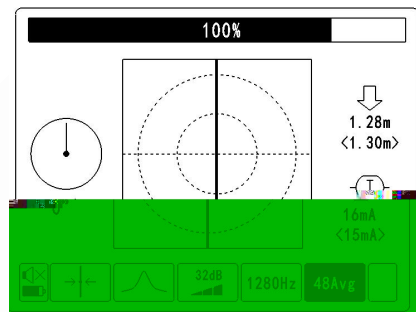

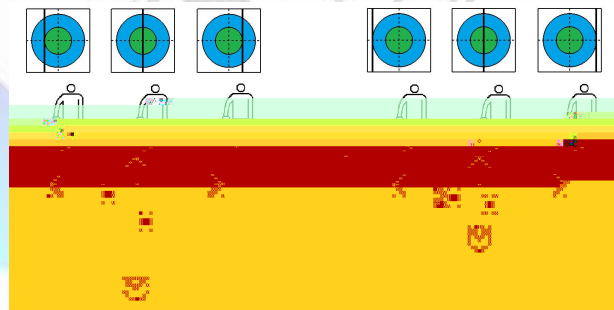
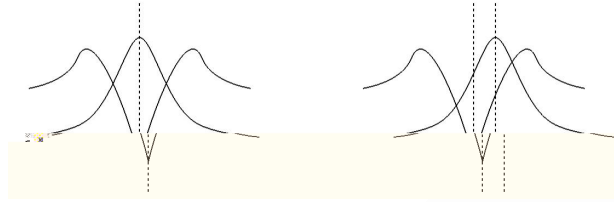



**赫兹电力**  
HERTZ POWER

产品宗旨：技术领先，质量可靠，轻便易用

服务宗旨：快速响应，达到满意，超过期望



**赫兹电力**  
HERTZ POWER

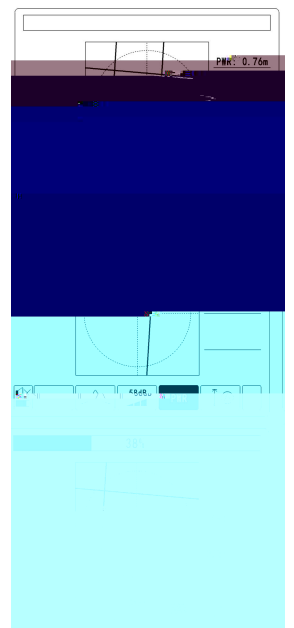
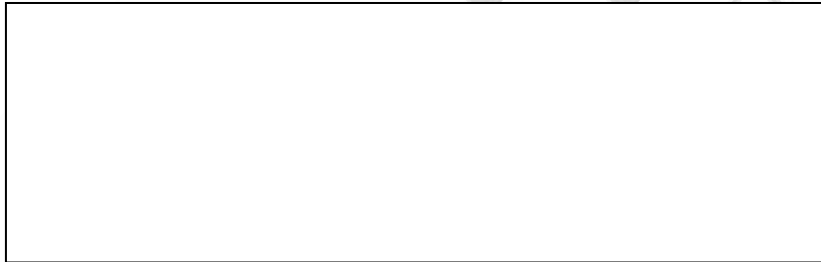



赫兹电力  
HERTZ POWER

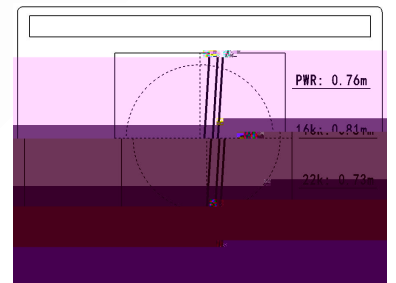

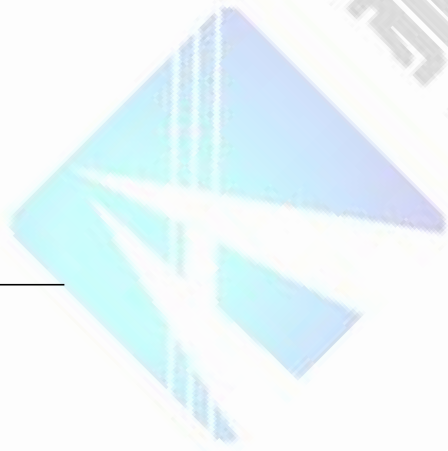
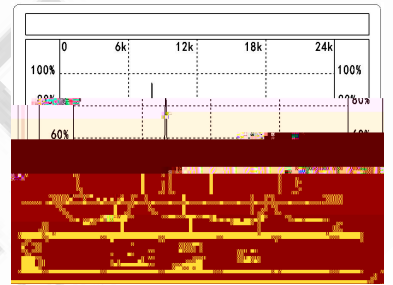
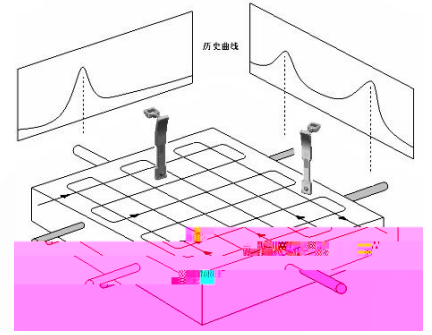

赫兹电力  
HERTZ POWER

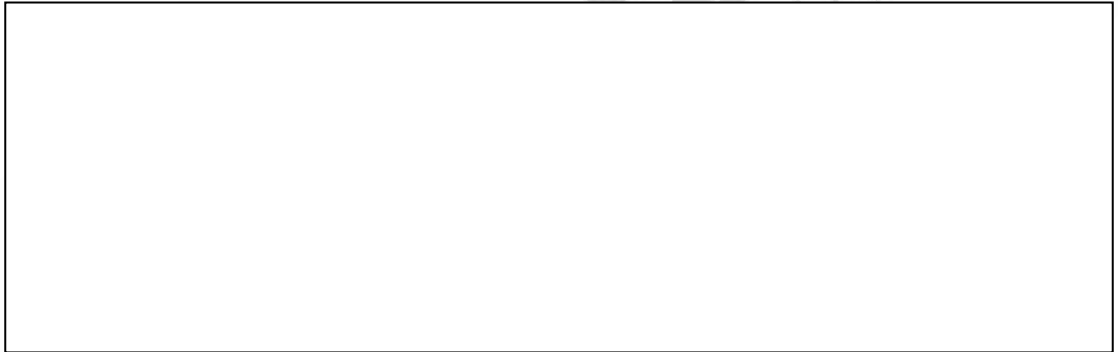
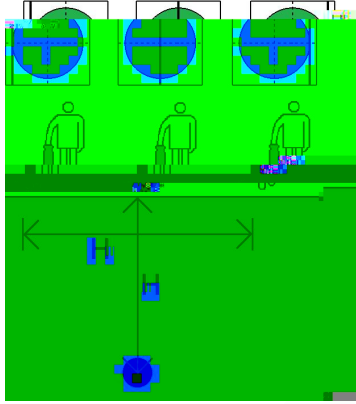

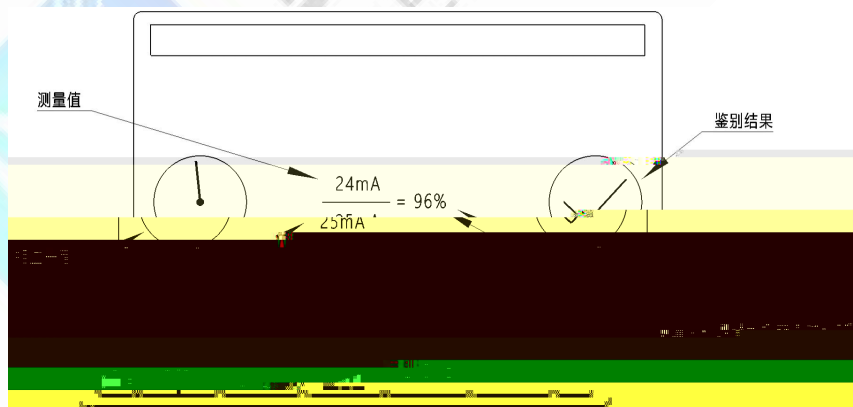
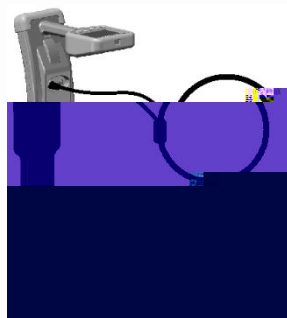

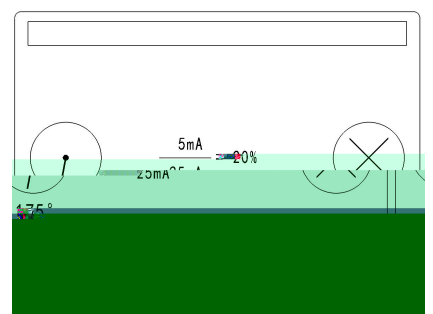
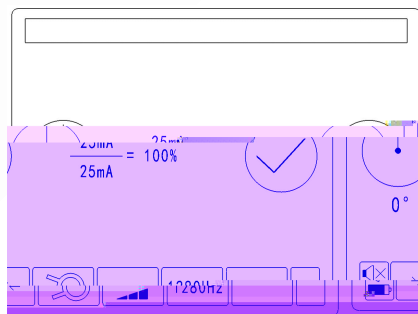
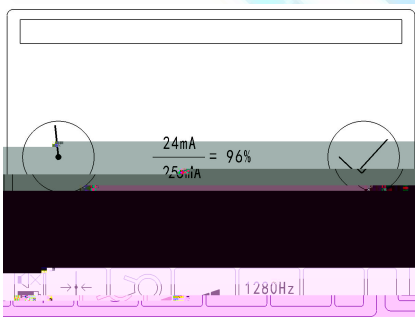

b. 识别正确

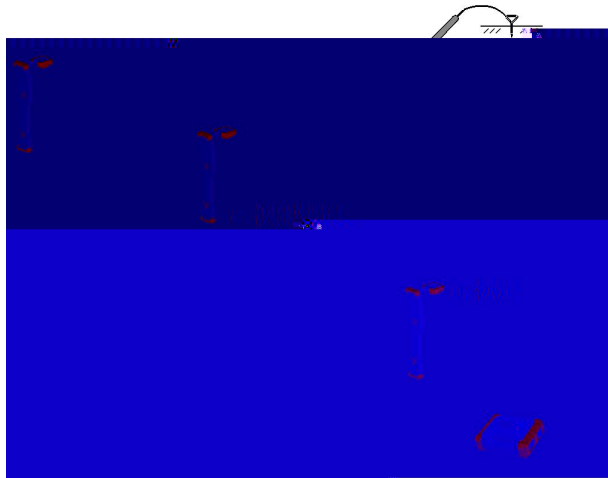

F\$?A009 V L \$ P È

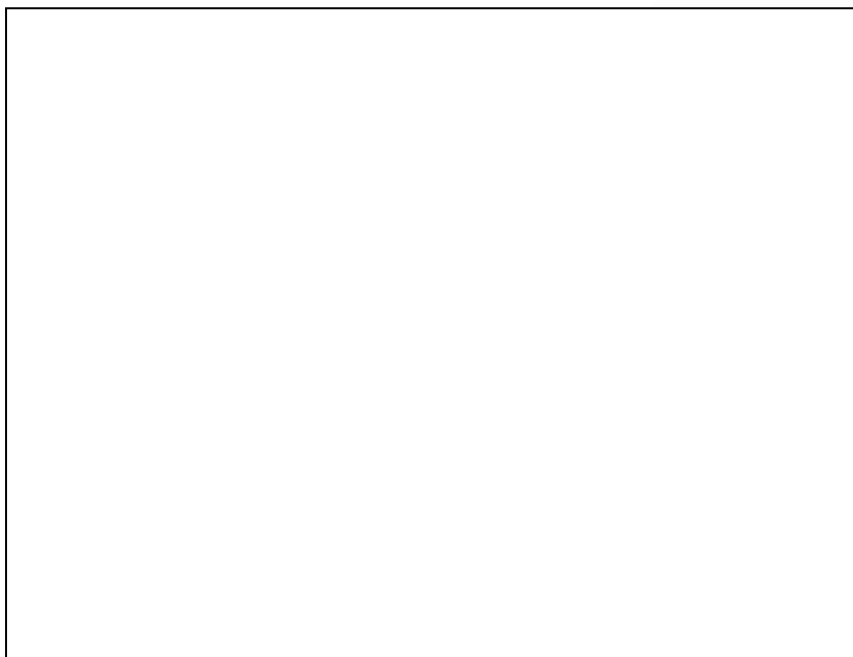

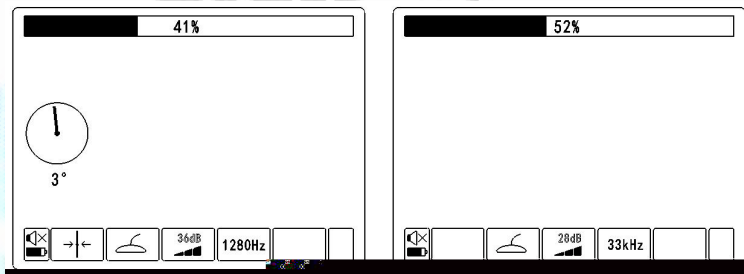
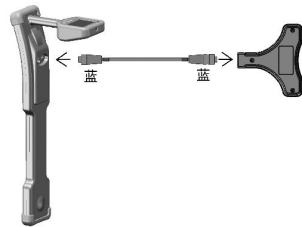



赫兹电力  
HERTZ POWER



**赫兹电力**  
HERTZ POWER



赫兹电力  
HERTZ POWER



赫兹电力  
HERTZ POWER



赫兹电力  
HERTZ POWER

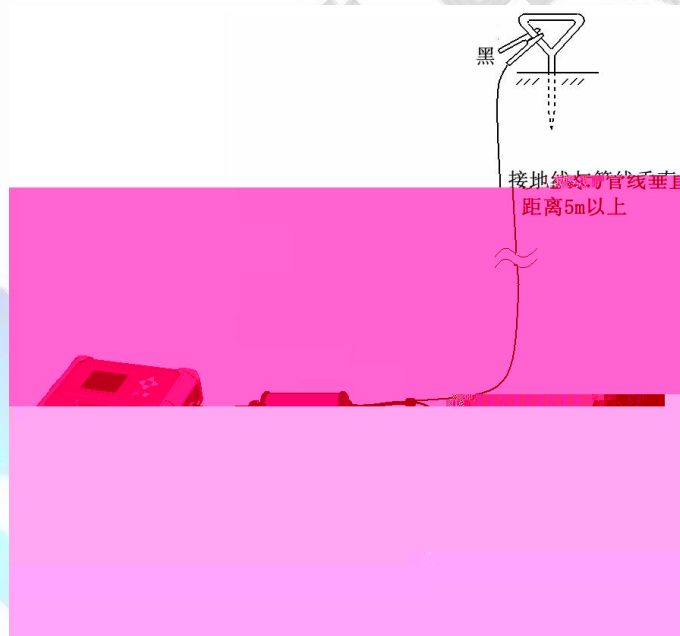
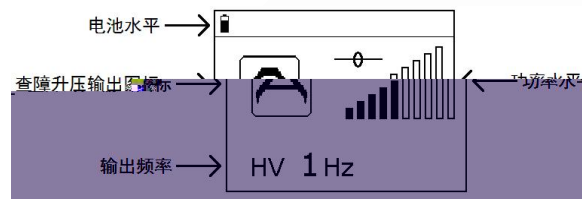
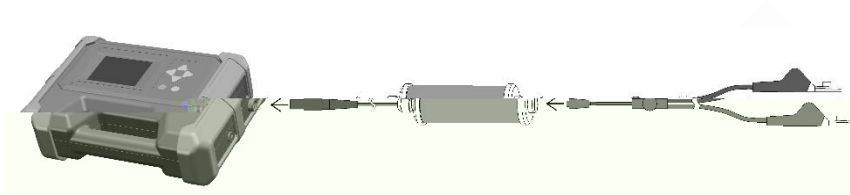

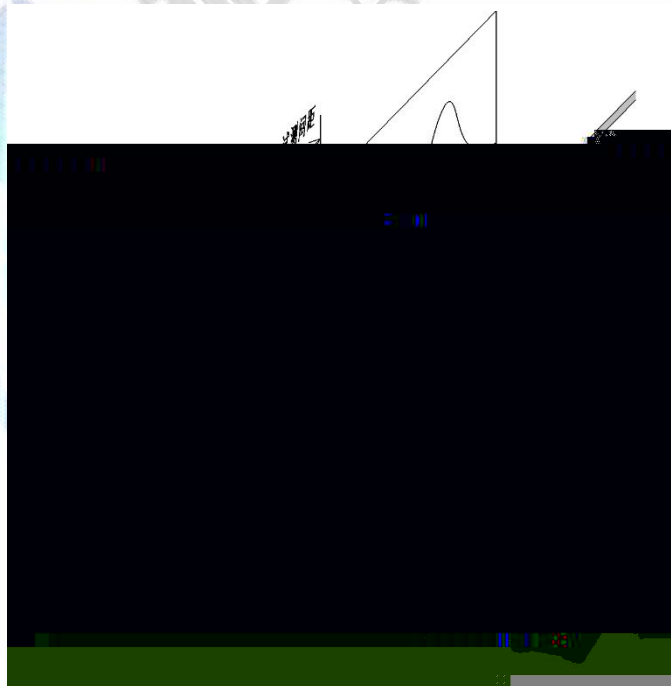
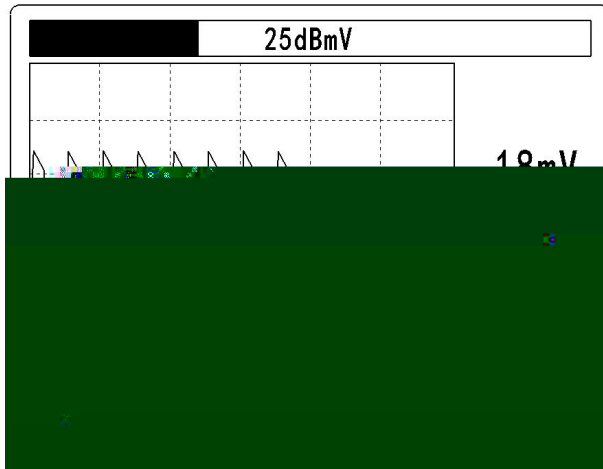
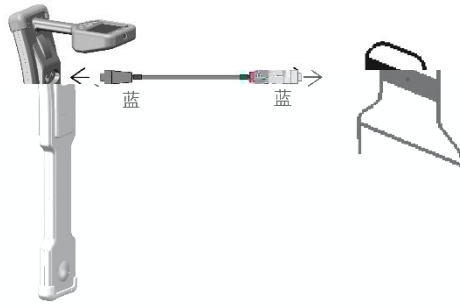

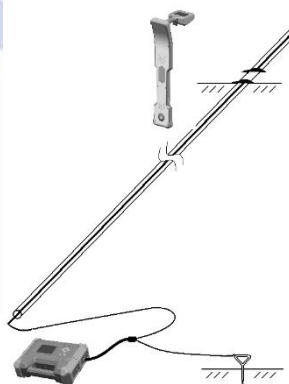
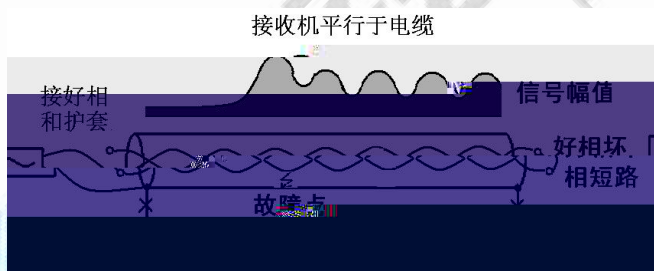
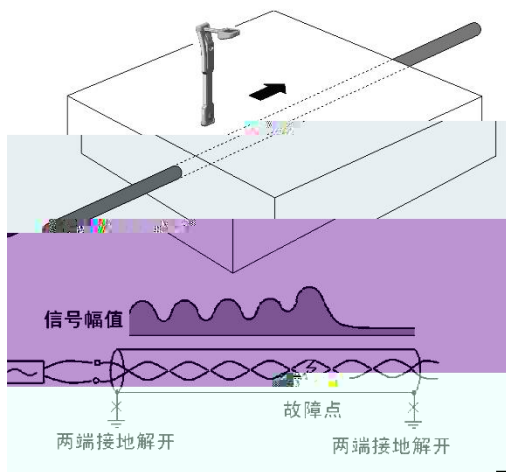

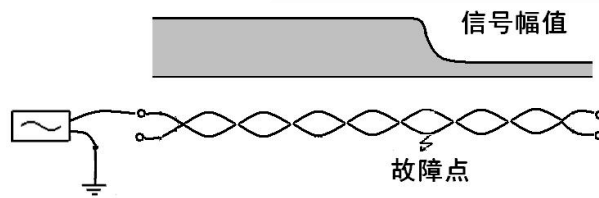
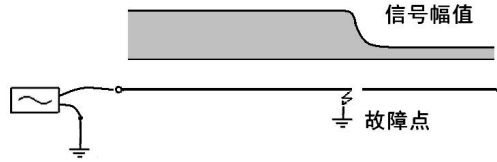

赫兹电力  
HERTZ POWER

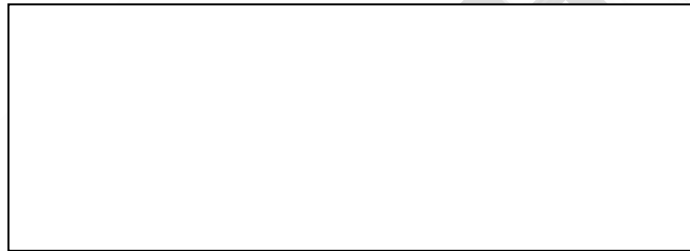
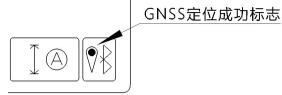

赫兹  
HERTZ

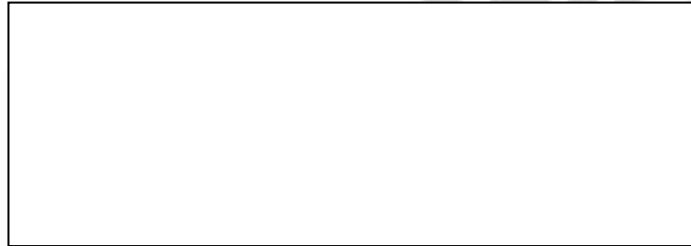

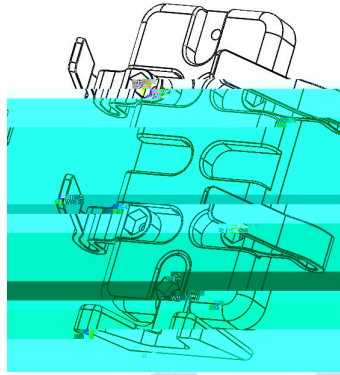
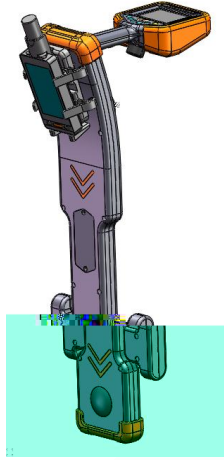

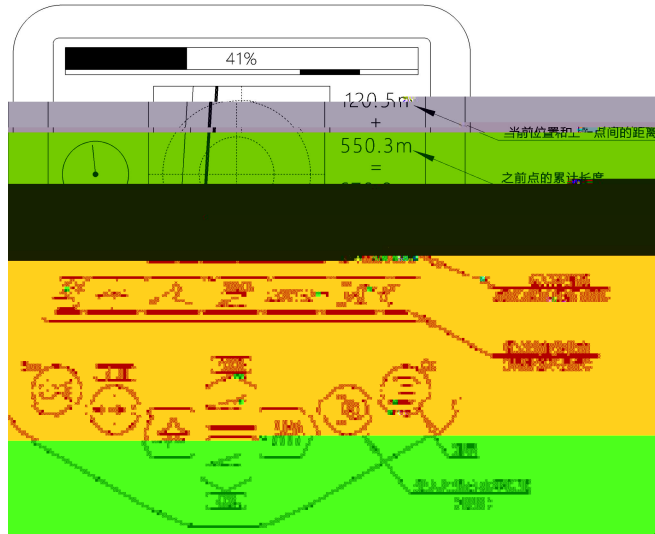

赫兹电力  
HERTZ POWER



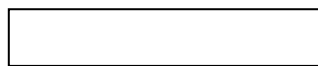

赫兹电力  
HERTZ POWER



赫兹连接技术有限公司

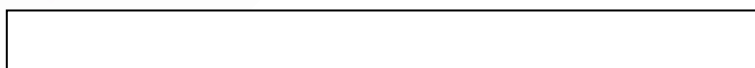



系统	名称	工频	单位	频率
发送全部				









--	--	--	--	--



系统	存储	工频	单位	频率	
----	----	----	----	----	--

发送全部

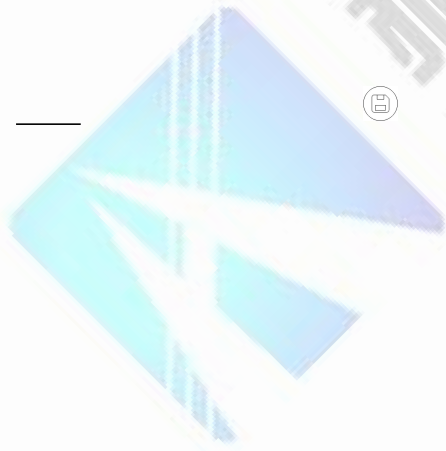
\* 蓝研



赫兹电力  
HERTZ POWER



赫兹电力  
HERTZ POWER



赫兹电力  
HERTZ POWER