



HZDWE



1

2

3

4

5

6

7

8

10



HZDWE

30A

HZDWE

HZDWE

50Hz

0.1Hz, 10Hz

50Hz 60Hz

FJE÷

0.005 9

U

PC

E÷

FJ

		$50 \pm 0.1\text{Hz}$	$50 \pm 10.0\text{Hz}$
		$60 \pm 0.1\text{Hz}$	$60 \pm 10.0\text{Hz}$
7	5A	30A	
8	400V	1000V	
9			1.5mm <sup>2</sup> 1.0mm <sup>2</sup>
10	2kW		
11	AC220V $\pm$ 10	50Hz	
12	500mm* 377mm* 330mm		20kg

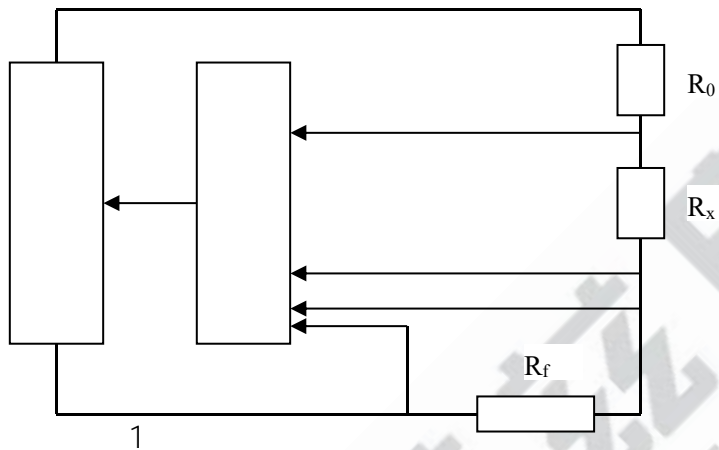

1	R <sub>0</sub>	5	200		
2	R <sub>x</sub>	0	200		
3	R <sub>f</sub>				
4	D			3 5	1.5mm <sup>2</sup>
5	1	0.618D		1.0mm <sup>2</sup>	
6	2				
7					

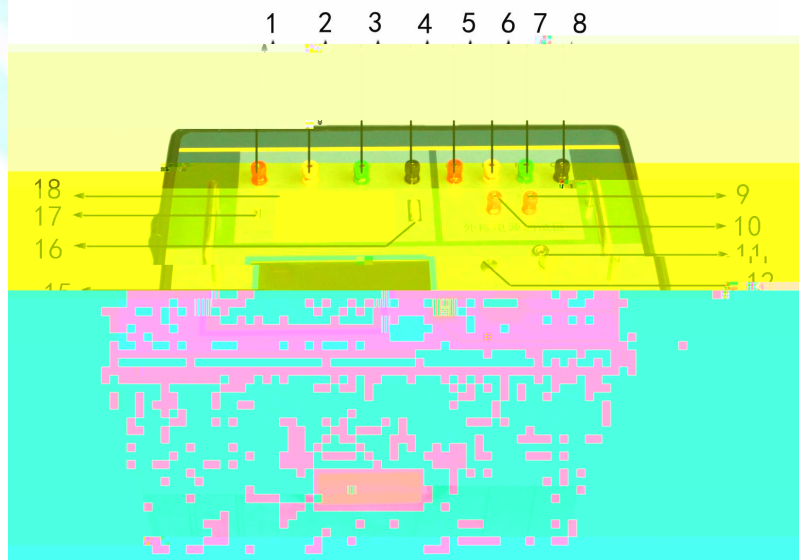

2

1	(C1)	2	(P1)	3	(P2)	4	(C2)
5	(C11)	6	(P11)	7	(P22)	8	(C22)
9		10					

11:	12:	13: 220V	14:
15:	16: 232	17: U	18:

5, 6, 7, 8, 9, 10

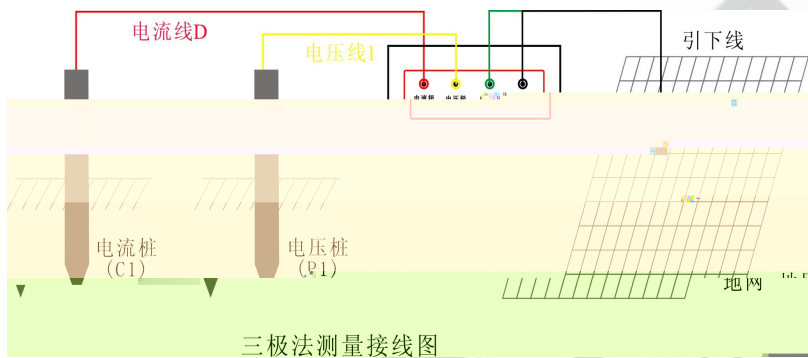

1	D	3	3	5
2	1	1.5mm <sup>2</sup> ,		
3	2	1.0 mm <sup>2</sup> ,	0.618	
4				

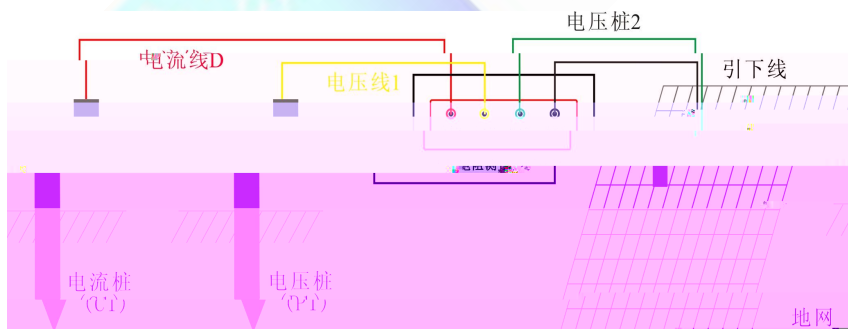

5	4	P2	C2
---	---	----	----

7.1

1

>0.5

- 2
- 5
- 3
- 4
- 5
- 6
- 7
- 8
- 7.2
- 1.

AC 220V/50Hz

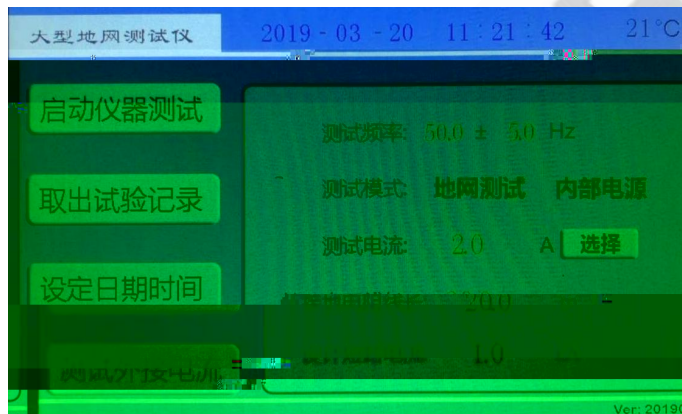

- 2
- 1) 50.0± 5.0Hz
- 60± 5Hz
- 40-70Hz
- 2) 45/55Hz
- 50Hz
- 50± 5Hz
- 50.0± 0.0Hz

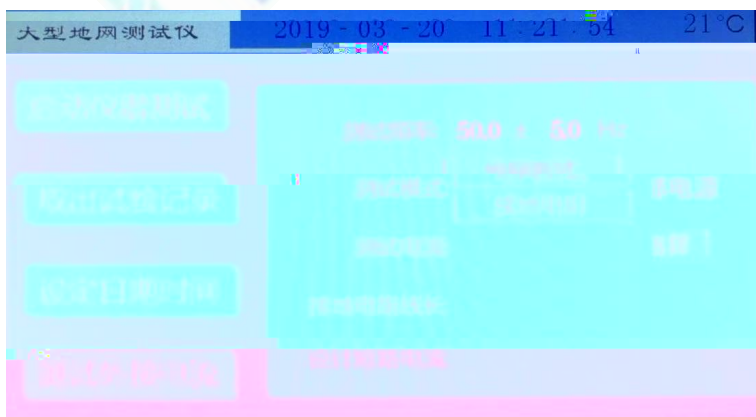

6

3)

7

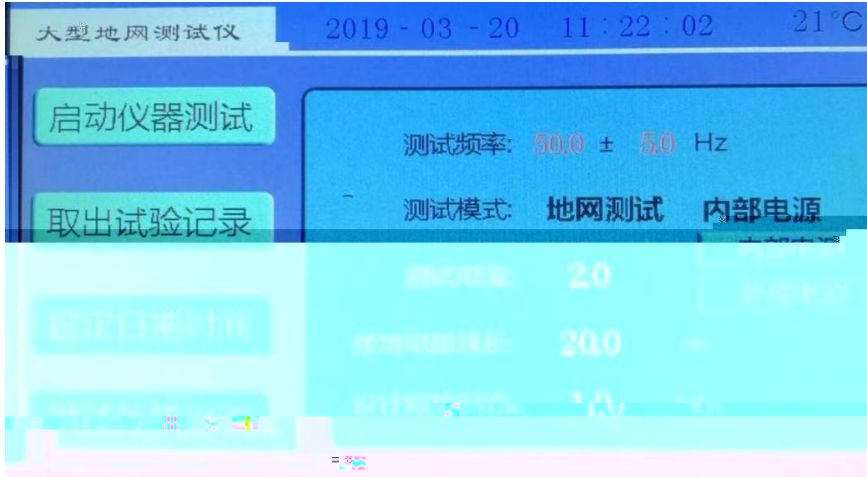

7

4)

2.0A

2.2A

8

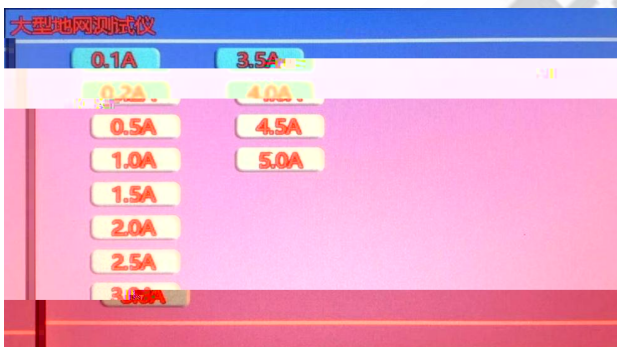

8

5A 20A  
20

5)

6)

7)

( 5)

1kA

9

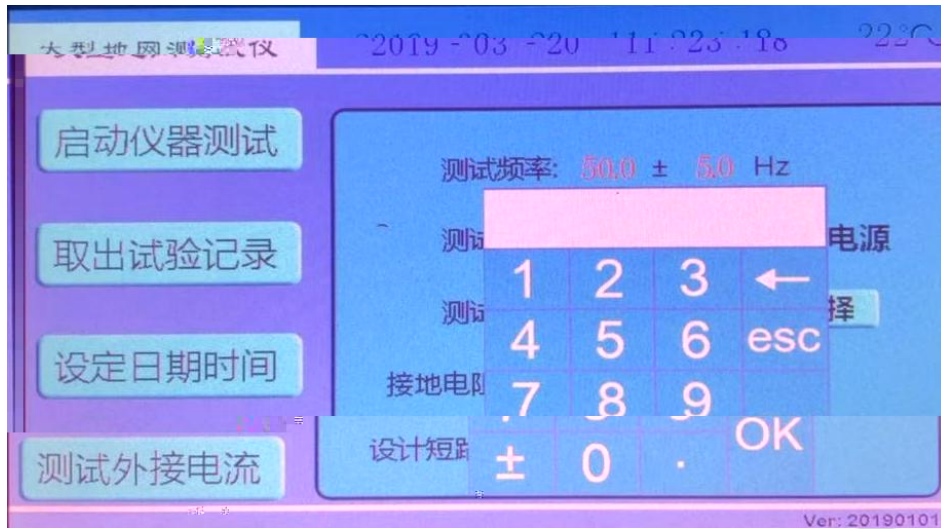

9

OK  
esc

7.3

( 5 )

10

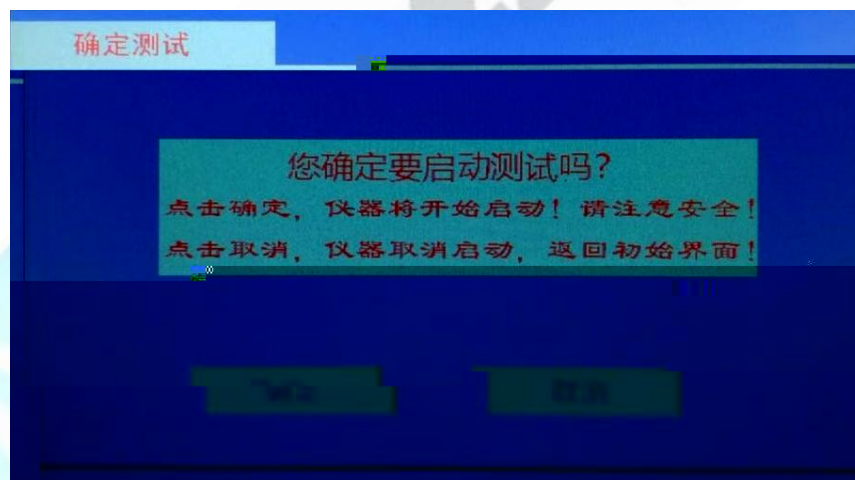

10

( 11 )

( 5 )



I = 2.000A  
U = 0.151V  
R = 0.075 Ω  
F = 55.00Hz  
F1  
F2  
84%  
100%  
84%



12

11

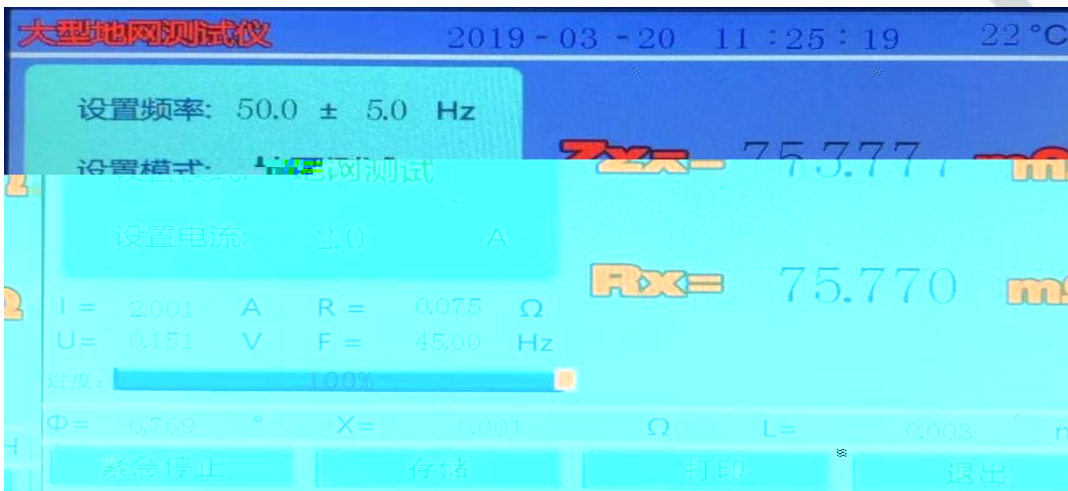

12

Zx = 75.777m Ω  
Rx = 75.770m Ω  
= 0.769°  
X = 0.001 Ω  
L = 0.003mH

( 5 )

13

- 1.
- 2.
- 3.

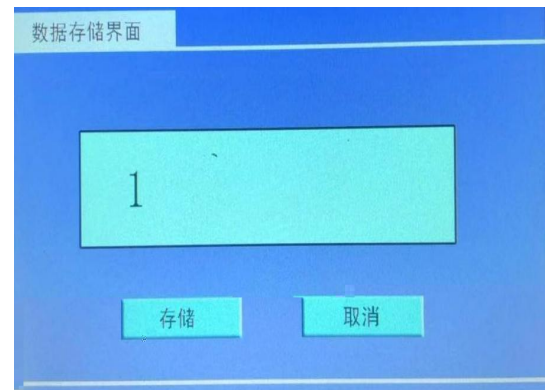

13

7.4

( 5)

20

14

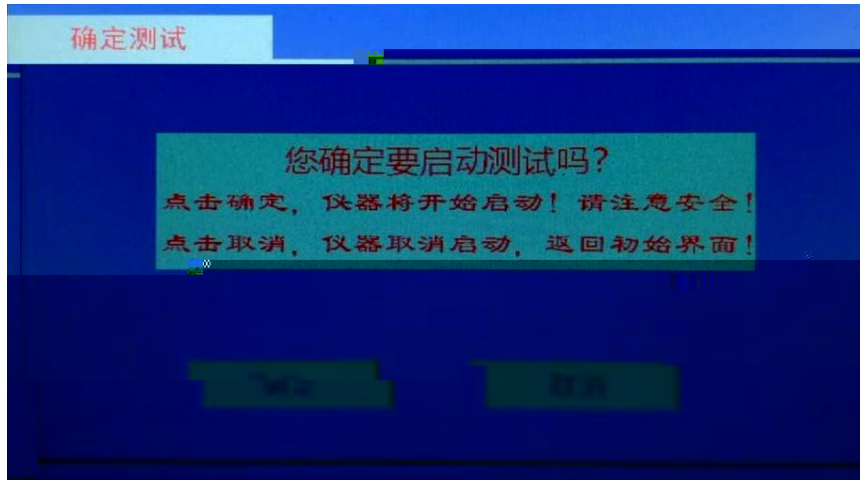

14

( 15)

( 5)



I=2.002A  
U=0.153V  
R=0.076  
F=55.00Hz  
F=45.00Hz

( F1)  
( F2)

84%  
100%

84%



15

16



16

R = 76.138m :  
 =9.567 .m :  
 I =2.000A :  
 U=0.152V :

( 5)

17

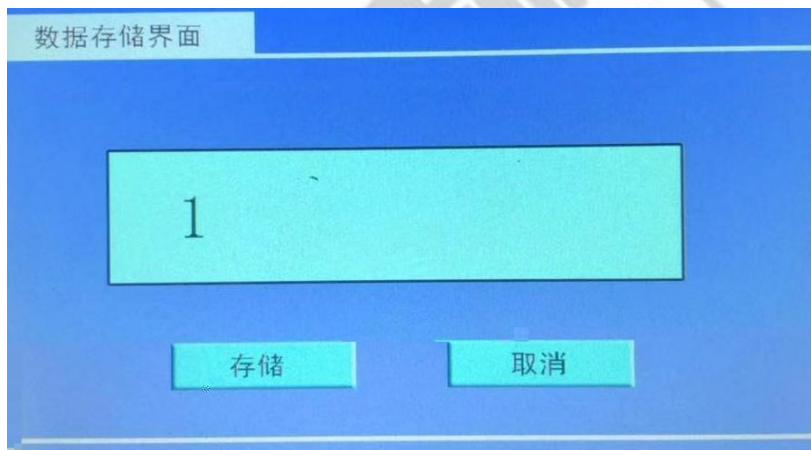

17

- 1.
- 2.
- 3.

7.5

- 1
- 2
- 3
- 4
- 5
- 6
- 7
- 8
- 4

0.0A

0.5m

80

0.01

C1

20

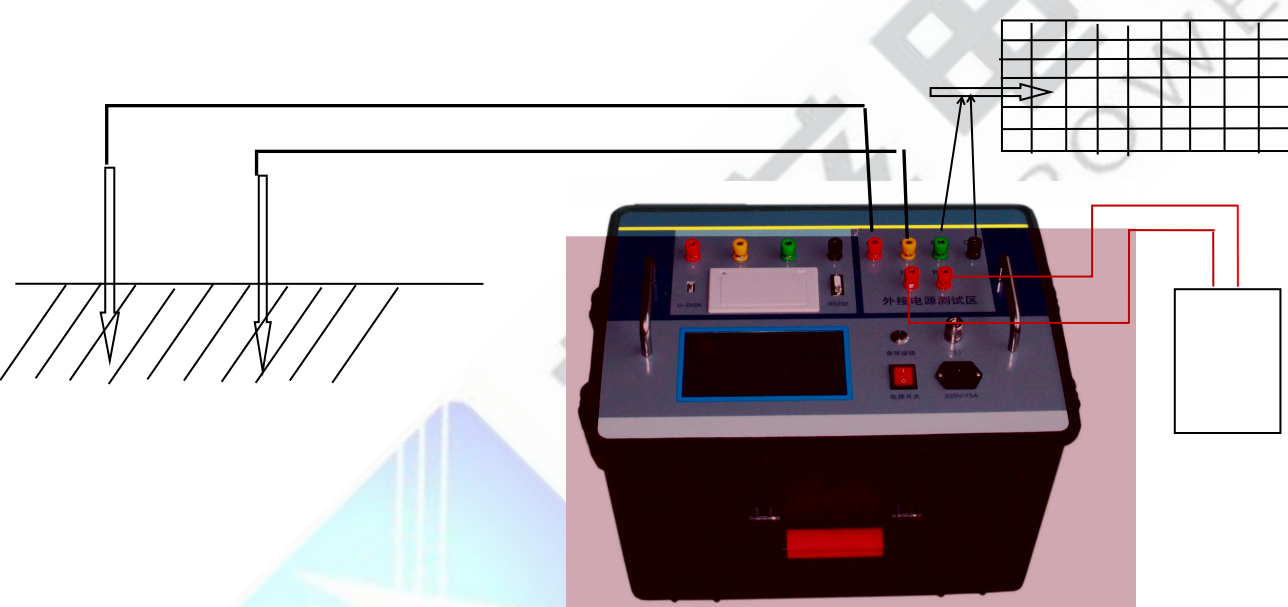

- 1.
- 2.
- 3.
- 4.
- 5.
- 6.

C1/P1

C2/P2

225

027-83267669

- 1
- 2
- 3
- 4

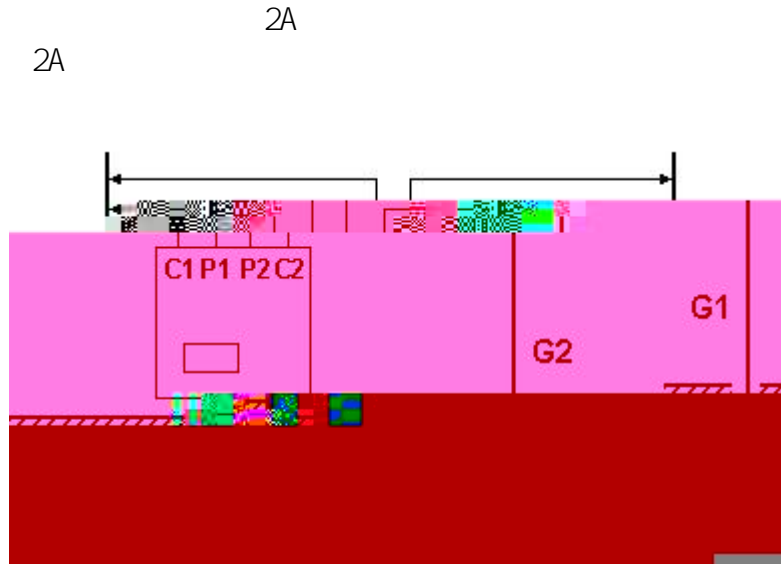

12

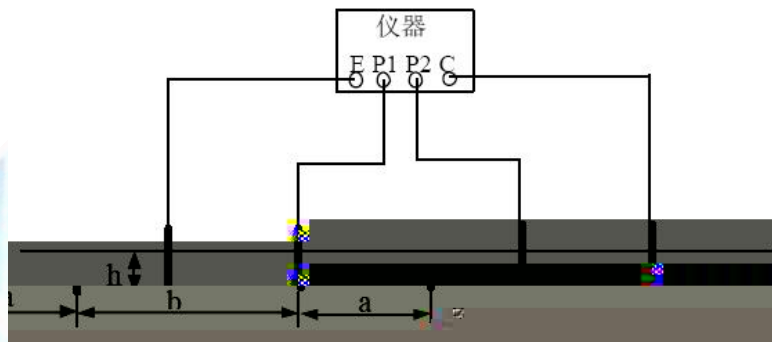

12

a                      b                      h                      a=b

                            a   b                      h,                      a   b>10h

1.5cm                      25mm× 25mm× 4mm

40cm

Z

$$= a(a+b)Z/b$$

a>>h    b>>h

$$a=b$$

$$=2 a$$



1

2

1.

2

1

2

3

027-83267669

4